

ÖZELLİKLER ve UYGULAMALAR

- Amonyaklı Soğutucular orta ve büyük hacimli soğuk ve donmuş muhafaza odaları, hızlı soğutma ve şok odaları için tasarlanmıştır.
- Friterm NES serisi standart olarak tek yönde üfleyen, emişe çalışan, standart tavana monte edilebilen evaporatörlerdir.
- Üç fazlı fana sahip ürünler, çift hızlı çalıştırıldığında başlangıçta hızlı soğutma, sonrasında da düşük hava sirkülasyonu ile daha az ürün kaybını hedefleyen soğutma işlemi yapabilmektedir.
- Friterm NES serisi çok çeşitli aksesuar seçenekleriyle 3 kW -250 kW aralığında 432 modelden oluşmaktadır.

Batarya Özellikleri

- 50 x 50 mm düz boru dizilişli,
- 15 mm AISI 304 paslanmaz çelik boru,
- 4-7-10-12 mm standart lamel aralıkları, diğer lamel aralıkları opsiyoneldir,
- Alüminyum lameller,
- AISI 304 paslanmaz çelik borulu giriş-çıkış bağlantıları,
- Bağlantılar standart olarak hava akış yönünün sağ tarafında yer alır,
- Optimum devreleme,
- Test Basıncı: 34 bar

KASETLEME

- Modele ve boyuta bağlı olarak AIMg₃ veya galvanizli çelik kasetleme yapılır.
- Elektrostatik toz boyalı (RAL 9016) kasetleme düzgün, kalıcı, korozyona dayanıklı dekoratif yapı oluşturur.
- Standart açılır-kapanır yan kapak bağlantılara kolay ulaşım imkanı sağlar.

Drenaj Tavası

- Model ve boyuta bağlı olarak açılır-kapanır veya sökülebilir tava uygulanır.
- İzolasyonlu drenaj tavası opsiyoneldir.

FANLAR

- Amonyaklı endüstriyel soğutucularda 400-450-500-630-800 mm çaplarda yüksek verimli aksiyel tipte Ziehl Abegg , EBM veya muadili fanlar kullanılmaktadır.
- Motor koruma tipi IP 44 ve IP 54; izolasyon sınıfı B ve F dir.
- En düşük çalışma sıcaklıkları tek fazlı fanlarda -25°C, üç fazlı fanlarda -40°C'dir.
- -40°C'den düşük çalışma koşullarında özel fanlar kullanılmalıdır.
- Fanlar standart olarak emme yönünde çalışmaktadır.
- Standart olarak 400/450 mm fanlar 230V 1-50 Hz; 500/630/800 mm fanlar 400V 3-50Hz,
- Üç fazlı fanlar standart olarak çift hızlıdır. Ayrıca hız kontrollü EC fanlar opsiyoneldir.
- Üç fazlı fanlara frekans invertörü ve sinüs filtresi ilavesi ile kademesiz fan devir ayarı yapılabilmektedir.
- Düşük sıcaklıklarda ve hava direnci yükseldiğinde motor korunumu için kullanılan termistörlerin bağlantıları mutlaka yapılmalıdır.
- Üfleme mesafesini artıran akış kuvvetlendiriciler opsiyoneldir.
- Friterm farklı markalarda fan kullanma hakkına sahiptir. Bu duruma bağlı olarak fan bilgilerinde kısmi farklılıklar olabilir.

SES SEVİYELERİ

- Ürünlerin ses basınç seviyeleri EN 13487 standardına uygun olarak katalogta verilmiştir.
- Ses seviyeleri hesaplanırken fan imalatçılarının vermiş olduğu ses gücü seviyeleri (LwA) kullanılmıştır.
- Ses seviyelerinin kritik olduğu durumlar için konunun uzmanına başvurunuz.

FEATURES and APPLICATIONS

- Ammonia coolers are specially designed for medium and large industrial cold room, frozen storage ,blast freezing and fast cooling room applications.
- Friterm NES ceiling mounted single discharge evaporators draws air across coils .
- Triphase fans provides coolers to be suitable for not only fast cooling but also low air circulation applications.
- Friterm NES series consist of 432 models with wide variety of accessories incorporates capacity range between 3 kW- 250 kW

Coil Block

- 50 x 50 mm straight alignment,
- 15 mm AISI 304 stainless steel tubes,
- 4-7-10-12 mm of standart fin pitches. Other fin pitches are optional,
- Aluminium fins,
- Inlet and outlet connectors are AISI 304 stainless steel,
- Standart refrigerant connections are positioned on the right hand side of the direction of the air flow.
- Optimized circuit design,
- Test Pressure: 34 bar

CASING

- Casing material is AIMg₃ or galvanised steel depending on model and dimensions.
- All products are powder coated with RAL 9016 providing high corrosion resistance, smooth surface and decorative appearance.
- Standart hinged side coverings provide easy access to connections.

Drip Tray

- Drip tray can be produced as hinged or dismountable depending on model and dimensions.
- Drip tray with insulation is optional.

FANS

- Highly efficient axial Ziehl Abegg, EBM or equivalent fans are used in 400-450-500-630-800 mm diameters.
- Motor protection IP44 and IP54; insulation class B and F.
- Minimum working temperatures are -25 °C for monophase fans and -40°C for triphase fans.
- Special fans should be used under operating conditions below -40°C.
- Fans are arranged for standart draw through air configuration.
- 400/450 mm fans 230V 1-50 Hz; 500/630/800 mm fans 400V 3-50Hz,
- Triphase fans can work at two different speeds. Furthermore, EC fans providing speed control are optional.
- Variable fan speed regulation can be achieved using triphase fans with frequency inverter and sine filter.
- Working at low ambient temperature and high air resistance; thermistors must be used for motor protection.
- Streamers providing extra air throw distance are optional.
- Friterm reserves the right to use fans of different manufacturers. Depending on the type, the fan data may slightly vary.

SOUND DATA

- Indicated sound pressure levels comply with EN 13487.
- Sound levels are obtained from sound power levels (LwA) of the fans.
- Consult an expert for critical sound requirements.

DEFROST

Sıcak Gaz Defrost

- Soğutucular standart olarak sıcak gaz defrost sistemine uygun olarak üretilmektedir.
- Yüksek ısı transfer katsayısına ve kompakt boru dizilişine sahip evaporatör bataryası sayesinde, kısa sürede ve etkili defrost işlemi gerçekleştirilir.
- Tavada özel tasarımı sıcak gaz boru demeti ile defrost opsiyoneldir.

Elektrik Defrost

- Elektrikli defrost; bataryada standart, tavada opsiyonel olarak uygulanmaktadır.

Sulu Defrost Hava Defrost

STANDART AKSESUARLAR

- Bataryada sıcak gaz defrost,
- Açılır-kapanır yan kapak,
- Açılır-kapanır veya sökülebilir drenaj tavası,

OPSİYONEL AKSESUARLAR

- Tavada sıcak gaz defrost bataryası,
- Elektrik defrost,
- Sulu defrost,
- Kaplamalı lameller,
- Kaplamalı batarya,
- Duvara asma aparatları,
- Zemine montaj ayakları,
- AISI 314 veya AISI 316 paslanmaz çelik kasetleme,
- Fan ısıtıcısı,
- Hava akış güçlendiricisi,
- Tekstil kanal bağlantısı,
- Tekstil defrost kapağı,
- Hız kontrol üniteleri,
- Şalterler,
- Farklı lamel aralığı seçenekleri,
- Farklı sıra sayısı seçenekleri,
- 60 Hz motor,
- EC fan,
- AISI 316 boru,
- İzolasyonu tava,
- Açılı fan davlumbazı,
- Basmaya çalışan fan konfigürasyonu.

PAKETLEME, MONTAJ ve BAKIM

- Ürünler montaj pozisyonunda ahşap ambalajlı olarak sevk edilir.
- Montaj ve bakım için işletme bakım talimatına bakınız.

ADLANDIRMA / CLASSIFICATION

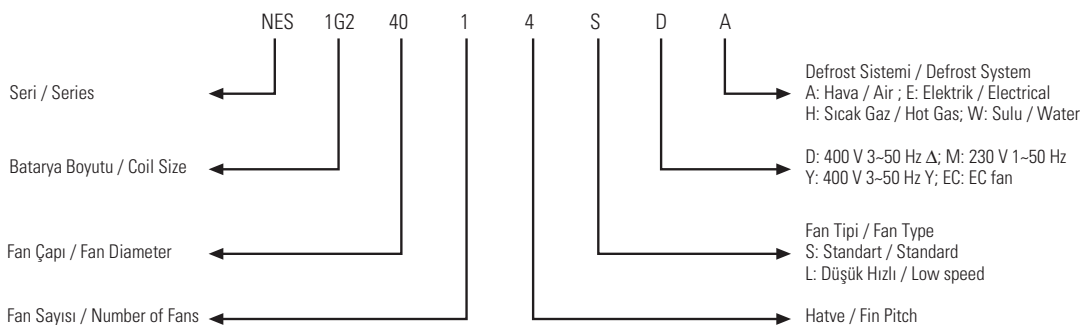

DEFROST

Hot Gas Defrost

- The standard coolers are suitable for hotgas defrost system.
- The compact evaporator coil with the small tube pitch and high heat transfer coefficient, ensures a uniform and effective defrosting and a short defrosting time.
- Hot gas defrost with tubes positioned in drip tray is optional.

Electrical Defrost

- Electrical defrost is a standard application in coilblock and optional in drip tray.

Water Defrost Air Defrost

STANDARD ACCESSORIES

- Hotgas defrost in coil,
- Hinged side coverings,
- Hinged or dismountable drip tray,

OPTIONAL ACCESSORIES

- Hot gas defrost in drip tray,
- Electrical defrost,
- Water defrost,
- Coated fins,
- Coated coilblock,
- Brackets for wall-mounting,
- Feet for floor-mounting,
- AISI 314 or AISI 316 stainless steel casing,
- Fan ring heaters,
- Air streamers,
- Textile hose connection,
- Defrost flap,
- Speed controllers,
- Motor protection switches,
- Other fin pitches ,
- Other number of rows,
- 60 Hz motors,
- EC fans,
- AISI 316 tubes ,
- Insulated drip tray,
- Fan hood,
- Blow-Through configuration system.

PACKING, MOUNTING and MAINTENANCE

- The units are delivered wooden packaged in mounting position.
- Please read operating and maintenance manual for mounting and maintenance .

FANLAR / FANS
MOTOR BİLGİLERİ / MOTOR DATA

Fan Çapı Fan Diameter	Fan Hızı (d/dk) Fan Speed (rpm)		Fan Gücü (kW) Fan Power (kW)		Fan Akım (A) Fan Current (A)		Ses Gücü Seviyesi (dBA) Sound Power Level (dBA)		Fan / Voltaj / Frekans Phase / Voltage / Frequency	Bağlantı Tipi Connection Type	
	Standart Standard	Düşük Hızlı Low Speed	Standart Standard	Düşük Hızlı Low Speed	Standart Standard	Düşük Hızlı Low Speed	Standart Standard	Düşük Hızlı Low Speed	~ / V / Hz	Standart Standard	Düşük Hızlı Low Speed
400	1430	-	0,16	-	0,73	-	74	-	1 / 230 / 50	A	
400	-	870	-	0,12	-	0,53	-	61	1 / 230 / 50		A
450	1310	-	0,49	-	2,36	-	68	-	1 / 230 / 50	B	
450	-	900	-	0,19	-	0,86	-	60	1 / 230 / 50		A
500	1330	940	0,83	0,55	1,45	0,97	77	71	3 / 400 / 50	C	D
500	870	590	0,29	0,15	0,74	0,36	67	58	3 / 400 / 50	C	D
630	1340	1070	1,9	1,35	3,2	2,2	90	85	3 / 400 / 50	C	D
630	900	720	0,63	0,44	1,25	0,73	74	69	3 / 400 / 50	C	D
800	890	690	1,8	1,15	3,8	2,2	79	74	3 / 400 / 50	C	D

Güç Düzeltme Faktörü / Power Consumption Factor

Düşük çalışma sıcaklıklarında fanların güç tüketimi artmaktadır. Tabloda verilen düzeltme faktörleri ortalama değerlerdir. Motor tipine bağlı olarak değişim gösterir.

The power consumption of fans increases with the lower ambient temperature. These average factor depends on motor type and pole number.

Sıcaklık / Temperature (°C)	20	10	0	-10	-20	-30	-40
Düzeltilme Faktörü / Correction factor	1	1,04	1,07	1,14	1,16	1,21	1,25

$$P_{corrected} = C_f \times P$$

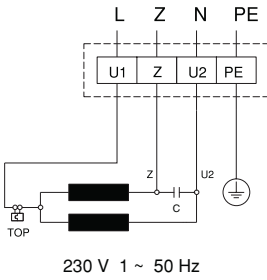
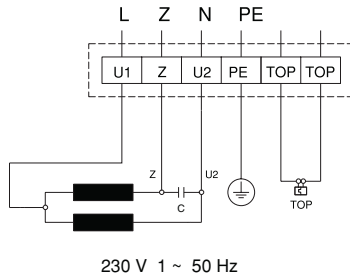
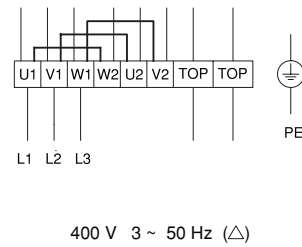
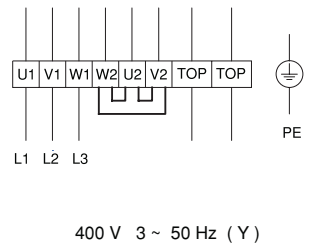
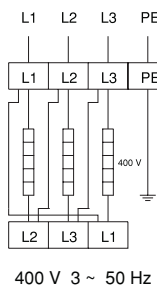
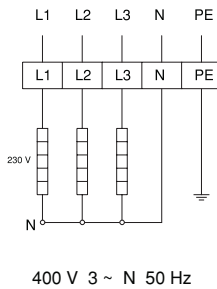
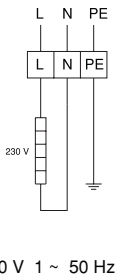
Fan Bağlantıları / Fan Connections
**A-) İç termistör bağlantısı
TOP wired internally**

**B-) Dış termistör bağlantısı
Connection for external TOP**

**C-) Üçgen termistör bağlantısı
Delta connection with TOP**

**D-) Yıldız termistör bağlantısı
Star connection with TOP**

Elektrik Defrost Bağlantıları / Electrical Defrost Connections

Friterm farklı markalarda fan kullanma hakkına sahiptir. Bu duruma bağlı olarak fan bilgilerinde kısmi farklılıklar olabilir. Friterm reserves the right to use fans of different manufacturers. Depending on the type, the fan data may slightly vary.

TOP: Thermal Overload Protection

KAPASİTE

- Kapasite değerleri pompalı sistem için SC1, SC2, SC3, SC4 şartlarında verilmiştir.
- Sirkülasyon oranı: 3,5
- Lamel kaplaması durumunda kapasite değerinde 3%'e varan azalma görülür.

Q_{ODA} : İstenen Kapasite
 Q_{KAT} : Katalog Kapasitesi (SC2)
 $T1$: Oda Sıcaklığı
 $T2$: Evaporasyon Sıcaklığı
 C_F : Düzeltme Faktörü

$$Q_{KAT} = \frac{Q_{ODA}}{C_F}$$

ÖRNEK: $T1: -8\text{ }^{\circ}\text{C}$, $T2: -15\text{ }^{\circ}\text{C}$, $Q_{ODA}: 20\text{ kW}$
 $\Delta T = T1 - T2 = -8 - (-15) = 7\text{ }^{\circ}\text{C}$
 $C_F = 0,78$ (tablodan)
 $Q_{KAT(SC2)} = Q_{ODA} / C_F = 20/0,78 = 25,6\text{ kW}$

CAPACITY

- The listed catalogue capacities are based on NH_3 pump operation for SC1, SC2, SC3 and SC4.
- Pump circulation: 3,5
- Capacities may decrease up to 3% due to coated fins.

Q_{ROOM} : Requested Capacity
 Q_{CAT} : Catalog Capacity (SC2)
 $T1$: Room Temperature
 $T2$: Evaporation Temperature
 C_F : Correction Factor

$$Q_{CAT} = \frac{Q_{ROOM}}{C_F}$$

EXAMPLE: $T1: -8\text{ }^{\circ}\text{C}$, $T2: -15\text{ }^{\circ}\text{C}$, $Q_{ROOM}: 20\text{ kW}$
 $\Delta T = T1 - T2 = -8 - (-15) = 7\text{ }^{\circ}\text{C}$
 $C_F = 0,78$ (from table)
 $Q_{CAT(SC2)} = Q_{ROOM} / C_F = 20/0,78 = 25,6\text{ kW}$

DÜZELTME FAKTÖRLERİ / CORRECTION FACTORS

Evaporator Sıcaklığı (°C) Evaporation Temperature (°C)	ΔT (°C)	12	11	10	9	8	7	6	5
	0	0	1,74	1,56	1,39	1,23	1,08	0,89	0,71
-5	-5	1,64	1,48	1,31	1,16	1,03	0,85	0,69	0,54
-8	-8	1,58	1,43	1,27	1,13	1,00	0,83	0,68	0,54
-10	-10	1,55	1,40	1,25	1,10	0,98	0,81	0,67	0,54
-15	-15	1,46	1,33	1,19	1,05	0,93	0,78	0,65	0,53
-20	-20	1,39	1,27	1,14	1,01	0,89	0,75	0,63	0,51
-25	-25	1,33	1,22	1,09	0,97	0,85	0,72	0,61	0,50
-30	-30	1,28	1,17	1,05	0,93	0,82	0,69	0,59	0,48
-35	-35	1,24	1,13	1,02	0,91	0,79	0,67	0,57	0,46
-40	-40	1,21	1,10	0,99	0,88	0,76	0,65	0,55	0,43

BAĞIL NEMİN, ODA İLE BUHARLAŞMA SICAKLIĞI FARKINA BAĞLI DEĞİŞİMİ

RELATIVE HUMIDITY VERSUS THE TEMPERATURE DIFFERENCE BETWEEN ROOM AND EVAPORATION

- Üründe kuruma ve ağırlık kaybını sınırlamak için oda bağıl nemi ve oda ile buharlaştırıcı arasındaki sıcaklık farkı grafiği göz önünde bulundurulmalıdır.
- Variation of relative humidity should be taken into consideration to determine the temperature difference between room and evaporator in order to limit the moisture loss from product surface.

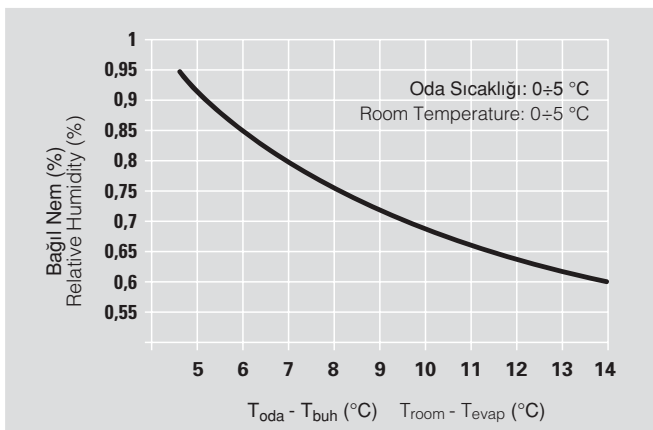

FRITERM ÜRÜN SEÇİM YAZILIMI

FRITERM PRODUCT SELECTION SOFTWARE

- Farklı kullanım şartlarında Friterm Ürün Seçim Yazılımı'nı kullanarak seçim yapabilirsiniz.
- Products can be selected in different conditions by using Friterm Product Selection Software.

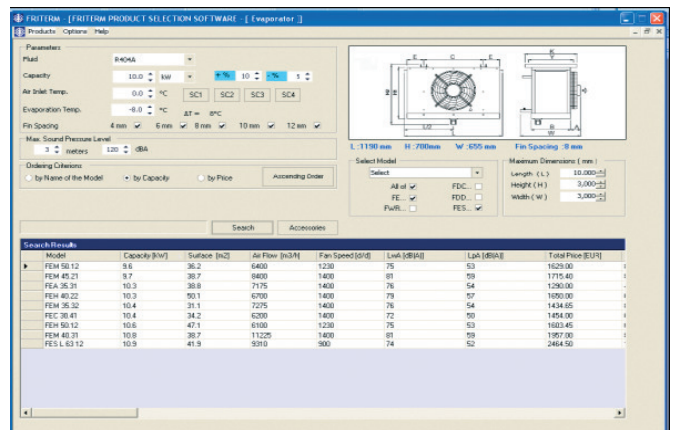

Friterm - FRITERM PRODUCT SELECTION SOFTWARE - [Evaporator]

Parameters:





- Fluid: NH_3
- Capacity: 100.0 l/h
- Air Inlet Temp.: 0.0 °C
- Evaporation Temp.: -8.0 °C
- Fin Spacing: 4 mm
- Max. Sound Pressure Level: 120 meters

Search Results:

Model	Capacity (l/h)	Surface (m2)	Air Flow (m3/h)	Fan Speed (rpm)	Load (kg/h)	L44 (kg/h)	L44 (kg/h)	Total Price (EUR)
FEM 50 L2	9.6	36.2	6400	1230	75	53	1625.00	
FEM 45 L1	9.7	38.7	8400	1400	81	59	1715.40	
FEM 35 L1	10.3	39.8	7175	1400	76	54	1290.00	
FEM 40 L2	10.3	50.1	6700	1400	79	57	1650.00	
FEM 35 L2	10.4	31.1	7275	1400	76	54	1434.05	
FEM 30 L1	10.4	34.2	6200	1400	72	50	1454.00	
FEM 50 L2	10.6	47.1	6100	1230	75	53	1883.45	
FEM 40 L1	10.9	38.7	11225	1400	81	59	1387.00	
FEM L 63 L2	10.9	41.9	9350	900	74	52	2464.50	

NES • 4 mm

KAPASİTE TABLOSU / CAPACITY TABLE

MODEL MODEL	Yüzey Surface	Kapasite Capacity				Hava Debisi Air Flow	Üfleme Mesafesi* Air Th row*	Akış kuvvetlendiricili with Streamer	Boru Hacmi Tube Volume	Bağlantılar Connections			Fanlar Fans				Defrost Isıtıcılar Electric Defrost		
		SC1	SC2	SC3	SC4					Giriş Inlet	Çıkış Outlet	Sıcak Gaz Giriş-Çıkış Hot Gas Inlet-Outlet	Fanlar Fans	Sayı Number	Güç Power	Ses Basınç Seviyesi Sound Pressure Level	Batarya Coil	Tava D.Tray	Toplam Güç Total Power
		DT=10 K Te=0°C	DT=8 K Te=-8°C	DT=7 K Te=-25°C	DT=6 K Te=-31°C					mm	mm	mm	mm	n	kW	(3m)dB(A)	kW	kW	kW
	m ²	kW	kW	kW	kW	m ³ /h	m	m	dm ³	mm	mm	mm	mm		kW	kW	kW	kW	
 x 1	1G2.40.1.4.S	31.4	6.7	4.5		2950	11	24	7.4	21.3	21.3	21.3	400	1	0.16	52	1.30	0.65	1.95
	1G4.40.1.4.S	47.1	8.6	5.8		2550	10	21	13.1	21.3	21.3	21.3	400	1	0.16	52	1.95	0.65	2.60
	1G6.40.1.4.S	62.9	9.2	6.3		2260	9	18	20.4	21.3	21.3	21.3	400	1	0.16	52	2.60	0.65	3.25
	1G2.45.1.4.S	46.4	10.5	7.1		5060	15	35	10.1	21.3	21.3	21.3	450	1	0.49	46	2.40	0.80	3.20
	1G4.45.1.4.S	69.6	14.0	9.3		4520	14	31	13.9	21.3	33.7	21.3	450	1	0.49	46	3.20	0.80	4.00
	1G6.45.1.4.S	92.8	16.5	11.2		4400	13	30	20.2	21.3	33.7	21.3	450	1	0.49	46	4.00	0.80	4.80
	1G2.50.1.4.S	77.4	17.0	11.4		7560	20	39	13.5	21.3	33.7	21.3	500	1	0.83	55	4.00	2.00	6.00
	1G4.50.1.4.S	116.0	22.4	15.1		6990	19	36	20.3	21.3	33.7	21.3	500	1	0.83	55	5.00	2.00	7.00
	1G6.50.1.4.S	154.7	25.7	17.2		6490	17	33	27.0	21.3	33.7	21.3	500	1	0.83	55	6.00	2.00	8.00
	1G2.63.1.4.S	116.0	28.2	18.6		14770	32	57	18.3	21.3	42.4	21.3	630	1	1.9	68	7.20	2.40	9.60
	1G4.63.1.4.S	174.1	38.0	25.8		13480	29	52	28.5	21.3	42.4	21.3	630	1	1.9	68	8.40	2.40	10.80
	1G6.63.1.4.S	232.1	43.4	28.7		12420	27	48	36.6	21.3	42.4	21.3	630	1	1.9	68	9.60	2.40	12.00
	1G2.80.1.4.S	185.7	42.1	28.7		19890	39	66	28.8	21.3	42.4	26.9	800	1	1.8	57	11.20	4.80	16.00
1G4.80.1.4.S	278.5	56.0	37.9		18120	35	60	43.2	21.3	48.3	26.9	800	1	1.8	57	12.80	4.80	17.60	
1G6.80.1.4.S	371.3	64.3	43.6		16590	32	55	57.5	21.3	48.3	26.9	800	1	1.8	57	14.40	4.80	19.20	
 x 2	1G2.40.2.4.S	62.9	13.5	8.9		5890	13	27	10.5	21.3	33.7	21.3	400	2	0.32	55	2.60	1.30	3.90
	1G4.40.2.4.S	94.3	17.2	11.6		5100	11	23	16.9	21.3	33.7	21.3	400	2	0.32	55	3.90	1.30	5.20
	1G6.40.2.4.S	125.7	18.6	12.8		4520	10	20	23.9	21.3	33.7	21.3	400	2	0.32	55	5.20	1.30	6.50
	1G2.45.2.4.S	92.8	21.2	14.4		10120	17	38	15.2	21.3	33.7	21.3	450	2	0.98	49	4.80	1.60	6.40
	1G4.45.2.4.S	139.2	27.9	19.0		9030	15	34	22.8	21.3	42.4	21.3	450	2	0.98	49	6.40	1.60	8.00
	1G6.45.2.4.S	185.7	33.3	22.5		8800	14	33	30.4	21.3	42.4	21.3	450	2	0.98	49	8.00	1.60	9.60
	1G2.50.2.4.S	154.7	34.3	23.0		15110	22	42	23.7	21.3	42.4	21.3	500	2	1.66	58	8.00	4.00	12.00
	1G4.50.2.4.S	232.1	45.0	30.2		13970	21	39	35.5	21.3	42.4	21.3	500	2	1.66	58	10.00	4.00	14.00
	1G6.50.2.4.S	309.4	51.4	34.6		12980	19	36	47.4	21.3	48.3	21.3	500	2	1.66	58	12.00	4.00	16.00
	1G2.63.2.4.S	232.1	56.3	37.2		29540	35	62	34.6	21.3	48.3	26.9	630	2	3.8	71	14.40	4.80	19.20
	1G4.63.2.4.S	348.1	74.9	49.6		26950	32	57	51.8	21.3	60.3	26.9	630	2	3.8	71	16.80	4.80	21.60
	1G6.63.2.4.S	464.2	86.7	57.4		24830	29	52	69.1	26.9	60.3	26.9	630	2	3.8	71	19.20	4.80	24.00
	1G2.80.2.4.S	371.3	84.7	57.4		39780	43	72	55.1	26.9	60.3	33.7	800	2	3.6	60	22.40	9.60	32.00
1G4.80.2.4.S	557.0	112.3	76.1		36230	39	66	82.6	26.9	76.1	33.7	800	2	3.6	60	25.60	9.60	35.20	
1G6.80.2.4.S	742.7	128.8	87.3		33170	36	60	110.1	33.7	76.1	33.7	800	2	3.6	60	28.80	9.60	38.40	
 x 3	1G2.40.3.4.S	94.3	20.3	13.8		8840	13	28	15.1	21.3	33.7	21.3	400	3	0.48	57	3.90	1.95	5.85
	1G4.40.3.4.S	141.4	25.9	17.5		7640	11	24	22.7	21.3	33.7	21.3	400	3	0.48	57	5.85	1.95	7.80
	1G6.40.3.4.S	188.6	28.6	19.3		6780	10	21	30.3	21.3	42.4	21.3	400	3	0.48	57	7.80	1.95	9.75
	1G2.45.3.4.S	139.2	32.2	21.5		15170	17	40	21.1	21.3	42.4	26.9	450	3	1.47	51	7.20	2.40	9.60
	1G4.45.3.4.S	208.9	41.9	27.9		13540	16	36	31.7	21.3	42.4	26.9	450	3	1.47	51	9.60	2.40	12.00
	1G6.45.3.4.S	278.5	50.0	33.9		13200	15	35	42.8	21.3	48.3	26.9	450	3	1.47	51	12.00	2.40	14.40
	1G2.50.3.4.S	232.1	50.2	33.0		22670	23	44	34.4	21.3	48.3	26.9	500	3	2.49	60	12.00	6.00	18.00
	1G4.50.3.4.S	348.1	67.7	45.7		20950	22	41	52.1	21.3	60.3	26.9	500	3	2.49	60	15.00	6.00	21.00
	1G6.50.3.4.S	464.2	76.3	52.1		19470	20	38	70.0	26.9	60.3	26.9	500	3	2.49	60	18.00	6.00	24.00
	1G2.63.3.4.S	348.1	85.4	57.9		44300	36	65	51.5	26.9	60.3	33.7	630	3	5.7	73	21.60	7.20	28.80
	1G4.63.3.4.S	522.2	114.9	77.8		40430	33	60	77.3	26.9	76.1	33.7	630	3	5.7	73	25.20	7.20	32.40
	1G6.63.3.4.S	696.2	134.1	90.8		37250	30	55	103.1	33.7	76.1	33.7	630	3	5.7	73	28.80	7.20	36.00
	1G2.80.3.4.S	557.0	127.1	86.3		59670	45	76	81.9	33.7	76.1	42.4	800	3	5.4	62	33.60	14.40	48.00
1G4.80.3.4.S	835.5	168.6	114.2		54350	41	69	122.9	33.7	88.9	42.4	800	3	5.4	62	38.40	14.40	52.80	
1G6.80.3.4.S	1114.0	193.3	131.0		49750	37	63	163.8	33.7	88.9	42.4	800	3	5.4	62	43.20	14.40	57.60	
 x 4	1G2.40.4.4.S	125.7	26.9	17.9		11790	14	29	19.0	21.3	33.7	26.9	400	4	0.64	58	5.20	2.60	7.80
	1G4.40.4.4.S	188.6	34.5	23.1		10190	12	25	28.7	21.3	42.4	26.9	400	4	0.64	58	7.80	2.60	10.40
	1G6.40.4.4.S	251.4	38.0	25.8		9040	11	22	38.9	21.3	42.4	26.9	400	4	0.64	58	10.40	2.60	13.00
	1G2.45.4.4.S	185.7	42.5	29.0		20230	18	42	27.9	21.3	42.4	26.9	450	4	1.96	52	9.60	3.20	12.80
	1G4.45.4.4.S	278.5	56.1	37.9		18050	16	37	41.9	21.3	48.3	26.9	450	4	1.96	52	12.80	3.20	16.00
	1G6.45.4.4.S	371.3	66.7	45.2		17600	16	36	55.8	21.3	60.3	26.9	450	4	1.96	52	16.00	3.20	19.20
	1G2.50.4.4.S	309.4	68.6	46.0		30220	24	46	45.7	21.3	60.3	26.9	500	4	3.32	61	16.00	8.00	24.00
	1G4.50.4.4.S	464.2	90.2	60.5		27940	23	43	68.6	26.9	60.3	26.9	500	4	3.32	61	20.00	8.00	28.00
	1G6.50.4.4.S	618.9	102.9	69.2		25950	21	40	91.5	26.9	60.3	26.9	500	4	3.32	61	24.00	8.00	32.00
	1G2.63.4.4.S	464.2	112.6	76.9		59070	38	68	68.4	26.9	76.1	33.7	630	4	7.6	74	28.80	9.60	38.40
	1G4.63.4.4.S	696.2	152.4	103.6		53900	35	62	102.5	33.7	88.9	33.7	630	4	7.6	74	33.60	9.60	43.20
	1G6.63.4.4.S	928.3	178.6	121.2		49660	32	57	136.7	33.7	88.9	33.7	630	4	7.6	74	38.40	9.60	48.00
	1G2.80.4.4.S	742.7	169.5	115.2		79560	46	79	108.9	33.7	88.9	42.4	800	4	7.2	63	44.80	19.20	64.00
1G4.80.4.4.S	1114.0	224.9	152.4		72460	42	72	163.4	33.7	88.9	42.4	800	4	7.2	63	51.20	19.20	70.40	
1G6.80.4.4.S	1485.																		

NES • 4 mm Düşük Hızlı • Low Speed

KAPASİTE TABLOSU / CAPACITY TABLE

MODEL MODEL	Yüzey Surface	Kapasite Capacity				Hava Debisi Air Flow	Üfleme Mesafesi* Air Th row*	Akış kuvvetlendiricili with Streamer	Boru Hacmi Tube Volume	Bağlantılar Connections			Fanlar Fans			Defrost Isıtıcılar Electric Defrost								
		SC1	SC2	SC3	SC4					Giriş Inlet	Çıkış Outlet	Sıcak Gaz Giriş-Çıkış Hot Gas Inlet-Outlet	Fanlar Fans	Sayısı Number	Güç Power	Ses Basınç Seviyesi Sound Pressure Level	Batarya Coil	Tava D.Tray	Toplam Güç Total Power					
		DT=10 K Te=0°C	DT=8 K Te=-8°C	DT=7 K Te=-25°C	DT=6 K Te=-31°C															mm	mm	mm	mm	n
	m ²	kW	kW	kW	kW	m ³ /h	m	m	dm ³	mm	mm	mm	mm											
x 1	1G2.40.1.4.L	31.4	5.6	3.7		2050	8	17	7.4	21.3	21.3	21.3	400	1	0.12	39	1.30	0.65	1.95					
	1G4.40.1.4.L	47.1	7.0	4.8		1800	7	15	13.1	21.3	21.3	21.3	400	1	0.12	39	1.95	0.65	2.60					
	1G6.40.1.4.L	62.9	7.9	5.4		1750	7	14	20.4	21.3	21.3	21.3	400	1	0.12	39	2.60	0.65	3.25					
	1G2.45.1.4.L	46.4	8.8	5.9		3260	10	22	10.1	21.3	21.3	21.3	450	1	0.19	38	2.40	0.80	3.20					
	1G4.45.1.4.L	69.6	10.6	7.0		2820	8	19	13.9	21.3	33.7	21.3	450	1	0.19	38	3.20	0.80	4.00					
	1G6.45.1.4.L	92.8	11.6	7.9		2540	8	17	20.2	21.3	33.7	21.3	450	1	0.19	38	4.00	0.80	4.80					
	1G2.50.1.4.L	77.4	13.9	9.3		4870	13	25	13.5	21.3	33.7	21.3	500	1	0.29	45	4.00	2.00	6.00					
	1G4.50.1.4.L	116.0	17.4	11.6		4500	12	23	20.3	21.3	33.7	21.3	500	1	0.29	45	5.00	2.00	7.00					
	1G6.50.1.4.L	154.7	18.9	12.6		4140	11	21	27.0	21.3	33.7	21.3	500	1	0.29	45	6.00	2.00	8.00					
	1G2.63.1.4.L	116.0	22.5	14.8		9090	19	35	18.3	21.3	42.4	21.3	630	1	0.63	52	7.20	2.40	9.60					
	1G4.63.1.4.L	174.1	30.0	20.2		8410	18	32	28.5	21.3	42.4	21.3	630	1	0.63	52	8.40	2.40	10.80					
1G6.63.1.4.L	232.1	32.2	21.3		7770	17	30	36.6	21.3	42.4	21.3	630	1	0.63	52	9.60	2.40	12.00						
x 2	1G2.40.2.4.L	62.9	11.3	7.4		4100	9	18	10.5	21.3	33.7	21.3	400	2	0.24	42	2.60	1.30	3.90					
	1G4.40.2.4.L	94.3	14.2	9.5		3600	8	16	16.9	21.3	33.7	21.3	400	2	0.24	42	3.90	1.30	5.20					
	1G6.40.2.4.L	125.7	15.8	10.8		3500	7	16	23.9	21.3	33.7	21.3	400	2	0.24	42	5.20	1.30	6.50					
	1G2.45.2.4.L	92.8	17.6	11.8		6510	11	25	15.2	21.3	33.7	21.3	450	2	0.38	41	4.80	1.60	6.40					
	1G4.45.2.4.L	139.2	21.6	14.6		5640	9	21	22.8	21.3	42.4	21.3	450	2	0.38	41	6.40	1.60	8.00					
	1G6.45.2.4.L	185.7	23.3	15.7		5080	8	19	30.4	21.3	42.4	21.3	450	2	0.38	41	8.00	1.60	9.60					
	1G2.50.2.4.L	154.7	27.8	18.6		9740	14	27	23.7	21.3	42.4	21.3	500	2	0.58	48	8.00	4.00	12.00					
	1G4.50.2.4.L	232.1	34.9	23.3		8990	13	25	35.5	21.3	42.4	21.3	500	2	0.58	48	10.00	4.00	14.00					
	1G6.50.2.4.L	309.4	37.8	25.4		8280	12	23	47.4	21.3	48.3	21.3	500	2	0.58	48	12.00	4.00	16.00					
	1G2.63.2.4.L	232.1	45.2	29.7		18180	21	38	34.6	21.3	48.3	26.9	630	2	1.26	55	14.40	4.80	19.20					
	1G4.63.2.4.L	348.1	57.8	38.1		16820	20	36	51.8	21.3	60.3	26.9	630	2	1.26	55	16.80	4.80	21.60					
1G6.63.2.4.L	464.2	64.5	42.5		15540	18	33	69.1	26.9	60.3	26.9	630	2	1.26	55	19.20	4.80	24.00						
x 3	1G2.40.3.4.L	94.3	17.2	11.6		6140	9	19	15.1	21.3	33.7	21.3	400	3	0.36	44	3.90	1.95	5.85					
	1G4.40.3.4.L	141.4	21.2	14.3		5400	8	17	22.7	21.3	33.7	21.3	400	3	0.36	44	5.85	1.95	7.80					
	1G6.40.3.4.L	188.6	24.0	16.2		5250	8	16	30.3	21.3	42.4	21.3	400	3	0.36	44	7.80	1.95	9.75					
	1G2.45.3.4.L	139.2	26.2	17.4		9770	11	26	21.1	21.3	42.4	26.9	450	3	0.57	43	7.20	2.40	9.60					
	1G4.45.3.4.L	208.9	31.9	21.2		8450	10	22	31.7	21.3	42.4	26.9	450	3	0.57	43	9.60	2.40	12.00					
	1G6.45.3.4.L	278.5	35.0	23.7		7620	9	20	42.8	21.3	48.3	26.9	450	3	0.57	43	12.00	2.40	14.40					
	1G2.50.3.4.L	232.1	40.4	26.5		14600	15	29	34.4	21.3	48.3	26.9	500	3	0.87	50	12.00	6.00	18.00					
	1G4.50.3.4.L	348.1	52.6	35.4		13480	14	26	52.1	21.3	60.3	26.9	500	3	0.87	50	15.00	6.00	21.00					
	1G6.50.3.4.L	464.2	57.3	39.1		12420	13	24	70.0	26.9	60.3	26.9	500	3	0.87	50	18.00	6.00	24.00					
	1G2.63.3.4.L	348.1	69.9	47.0		27270	22	40	51.5	26.9	60.3	33.7	630	3	1.89	57	21.60	7.20	28.80					
	1G4.63.3.4.L	522.2	90.2	60.7		25230	21	37	77.3	26.9	76.1	33.7	630	3	1.89	57	25.20	7.20	32.40					
1G6.63.3.4.L	696.2	100.6	67.7		23310	19	34	103.1	33.7	76.1	33.7	630	3	1.89	57	28.80	7.20	36.00						
x 4	1G2.40.4.4.L	125.7	22.5	14.9		8190	10	20	19.0	21.3	33.7	26.9	400	4	0.48	45	5.20	2.60	7.80					
	1G4.40.4.4.L	188.6	28.1	18.7		7200	8	18	28.7	21.3	42.4	26.9	400	4	0.48	45	7.80	2.60	10.40					
	1G6.40.4.4.L	251.4	32.1	21.6		7000	8	17	38.9	21.3	42.4	26.9	400	4	0.48	45	10.40	2.60	13.00					
	1G2.45.4.4.L	185.7	35.3	23.8		13040	12	27	27.9	21.3	42.4	26.9	450	4	0.76	44	9.60	3.20	12.80					
	1G4.45.4.4.L	278.5	43.4	29.2		11270	10	23	41.9	21.3	48.3	26.9	450	4	0.76	44	12.80	3.20	16.00					
	1G6.45.4.4.L	371.3	46.6	31.5		10150	9	21	55.8	21.3	60.3	26.9	450	4	0.76	44	16.00	3.20	19.20					
	1G2.50.4.4.L	309.4	55.7	37.1		19470	16	30	45.7	21.3	60.3	26.9	500	4	1.16	51	16.00	8.00	24.00					
	1G4.50.4.4.L	464.2	69.8	46.6		18000	15	28	68.6	26.9	60.3	26.9	500	4	1.16	51	20.00	8.00	28.00					
	1G6.50.4.4.L	618.9	75.8	50.8		16560	13	25	91.5	26.9	60.3	26.9	500	4	1.16	51	24.00	8.00	32.00					
	1G2.63.4.4.L	464.2	92.9	62.7		36360	23	42	68.4	26.9	76.1	33.7	630	4	2.52	58	28.80	9.60	38.40					
	1G4.63.4.4.L	696.2	120.3	81.1		33640	22	39	102.5	33.7	88.9	33.7	630	4	2.52	58	33.60	9.60	43.20					
1G6.63.4.4.L	928.3	134.4	90.8		31080	20	36	136.7	33.7	88.9	33.7	630	4	2.52	58	38.40	9.60	48.00						

*Katalogda verilen üfleme mesafesi değerleri ideal durum içindir. Fanların üfleme performansı çalışma koşullarına bağlı olarak (oda içi yerleşim, hava sıcaklığı, kar kalınlığı vb.) değişiklik gösterir.

*The indicated air throws are valid for ideal conditions. Fans' air throw performance may vary because of the surrounding conditions such as spatial dimensions, installation, air cooling, frost formation.

NES • 7 mm
KAPASİTE TABLOSU / CAPACITY TABLE

MODEL MODEL	Yüzey Surface	Kapasite Capacity				Hava Debisi Air Flow	Üfleme Mesafesi* Air Th row*	Akış kuvvetlendiricili with Streamer	Boru Hacmi Tube Volume	Bağlantılar Connections			Fanlar Fans			Defrost Isıtıcılar Electric Defrost			
		SC1	SC2	SC3	SC4					Giriş Inlet	Çıkış Outlet	Sıcak Gaz Giriş-Çıkış Hot Gas Inlet-Outlet	Fanlar Fans	Sayısı Number	Güç Power	Ses Basınç Seviyesi Sound Pressure Level	Batarya Coil	Tava D.Tray	Toplam Güç Total Power
		DT=10 K Te=0°C	DT=8 K Te=-8°C	DT=7 K Te=-25°C	DT=6 K Te=-31°C														
	x 1																		
	1G2.40.1.7.S	18.5	5.2	3.5	2.6	3260	13	27	6.0	21.3	21.3	21.3	400	1	0.16	52	1.30	0.65	1.95
	1G4.40.1.7.S	27.7	7.3	5.0	3.7	2880	11	24	10.0	21.3	21.3	21.3	400	1	0.16	52	1.95	0.65	2.60
	1G6.40.1.7.S	37.0	8.6	5.8	4.3	2600	10	21	14.8	21.3	21.3	21.3	400	1	0.16	52	2.60	0.65	3.25
	1G2.45.1.7.S	27.3	8.3	5.6	4.2	5440	16	37	8.4	21.3	21.3	21.3	450	1	0.49	46	2.40	0.80	3.20
	1G4.45.1.7.S	40.9	11.4	7.7	5.7	5000	15	34	12.0	21.3	33.7	21.3	450	1	0.49	46	3.20	0.80	4.00
	1G6.45.1.7.S	54.6	14.1	9.5	7.1	4610	14	32	16.9	21.3	33.7	21.3	450	1	0.49	46	4.00	0.80	4.80
	1G2.50.1.7.S	45.5	13.1	8.7	6.6	7940	21	41	12.4	21.3	33.7	21.3	500	1	0.83	55	4.00	2.00	6.00
	1G4.50.1.7.S	68.2	18.4	12.4	9.2	7480	20	38	19.5	21.3	33.7	21.3	500	1	0.83	55	5.00	2.00	7.00
	1G6.50.1.7.S	91.0	22.5	15.0	11.2	7100	19	36	24.8	21.3	33.7	21.3	500	1	0.83	55	6.00	2.00	8.00
	1G2.63.1.7.S	68.2	21.3	13.8	10.6	15650	33	60	17.6	21.3	33.7	21.3	630	1	1.9	68	7.20	2.40	9.60
	1G4.63.1.7.S	102.4	31.3	21.0	15.9	14630	31	56	27.0	21.3	42.4	21.3	630	1	1.9	68	8.40	2.40	10.80
	1G6.63.1.7.S	136.5	38.1	25.9	19.1	13710	29	53	36.7	21.3	42.4	21.3	630	1	1.9	68	9.60	2.40	12.00
1G2.80.1.7.S	109.2	33.0	22.1	16.6	21100	41	70	28.0	21.3	42.4	26.9	800	1	1.8	57	11.20	4.80	16.00	
1G4.80.1.7.S	163.8	46.5	31.2	23.4	19650	38	65	41.9	21.3	42.4	26.9	800	1	1.8	57	12.80	4.80	17.60	
1G6.80.1.7.S	218.4	56.7	38.0	28.6	18360	36	61	55.9	21.3	48.3	26.9	800	1	1.8	57	14.40	4.80	19.20	
	x 2																		
	1G2.40.2.7.S	37.0	10.5	6.9	5.2	6510	14	29	9.9	21.3	33.7	21.3	400	2	0.32	55	2.60	1.30	3.90
	1G4.40.2.7.S	55.5	14.8	9.9	7.5	5760	12	26	15.3	21.3	33.7	21.3	400	2	0.32	55	3.90	1.30	5.20
	1G6.40.2.7.S	73.9	17.3	11.8	8.6	5190	11	23	21.1	21.3	33.7	21.3	400	2	0.32	55	5.20	1.30	6.50
	1G2.45.2.7.S	54.6	16.7	11.2	8.4	10870	18	41	14.4	21.3	33.7	21.3	450	2	0.98	49	4.80	1.60	6.40
	1G4.45.2.7.S	81.9	23.4	15.8	11.9	10000	16	38	21.6	21.3	33.7	21.3	450	2	0.98	49	6.40	1.60	8.00
	1G6.45.2.7.S	109.2	28.4	19.1	14.4	9220	15	35	28.8	21.3	42.4	21.3	450	2	0.98	49	8.00	1.60	9.60
	1G2.50.2.7.S	91.0	26.2	17.4	13.2	15870	23	45	23.1	21.3	33.7	21.3	500	2	1.66	58	8.00	4.00	12.00
	1G4.50.2.7.S	136.5	36.9	25.1	18.5	14960	22	42	35.1	21.3	42.4	21.3	500	2	1.66	58	10.00	4.00	14.00
	1G6.50.2.7.S	182.0	44.9	29.9	22.6	14200	21	40	46.3	21.3	42.4	21.3	500	2	1.66	58	12.00	4.00	16.00
	1G2.63.2.7.S	136.5	43.2	29.4	21.5	31290	37	66	34.6	21.3	42.4	26.9	630	2	3.8	71	14.40	4.80	19.20
	1G4.63.2.7.S	204.7	61.8	42.0	30.9	29260	34	62	51.9	21.3	48.3	26.9	630	2	3.8	71	16.80	4.80	21.60
	1G6.63.2.7.S	273.0	76.6	51.9	38.4	27420	32	58	69.2	21.3	60.3	26.9	630	2	3.8	71	19.20	4.80	24.00
1G2.80.2.7.S	218.4	66.3	44.3	33.4	42200	45	77	54.7	21.3	48.3	33.7	800	2	3.6	60	22.40	9.60	32.00	
1G4.80.2.7.S	327.6	93.3	62.4	47.1	39300	42	72	82.0	26.9	60.3	33.7	800	2	3.6	60	25.60	9.60	35.20	
1G6.80.2.7.S	436.8	113.5	76.0	57.5	36720	39	67	109.4	26.9	76.1	33.7	800	2	3.6	60	28.80	9.60	38.40	
	x 3																		
	1G2.40.3.7.S	55.5	16.2	10.9	8.1	9760	15	31	14.5	21.3	33.7	21.3	400	3	0.48	57	3.90	1.95	5.85
	1G4.40.3.7.S	83.2	22.1	14.9	11.1	8640	13	27	21.7	21.3	33.7	21.3	400	3	0.48	57	5.85	1.95	7.80
	1G6.40.3.7.S	110.9	26.2	17.7	13.3	7840	12	24	28.9	21.3	33.7	21.3	400	3	0.48	57	7.80	1.95	9.75
	1G2.45.3.7.S	81.9	25.2	16.8	12.6	16300	19	43	20.9	21.3	33.7	26.9	450	3	1.47	51	7.20	2.40	9.60
	1G4.45.3.7.S	122.8	35.1	23.8	17.7	15000	17	40	31.4	21.3	42.4	26.9	450	3	1.47	51	9.60	2.40	12.00
	1G6.45.3.7.S	163.8	42.7	28.7	21.6	13820	16	36	41.8	21.3	42.4	26.9	450	3	1.47	51	12.00	2.40	14.40
	1G2.50.3.7.S	136.5	39.3	26.6	19.5	23810	25	47	34.5	21.3	42.4	26.9	500	3	2.49	60	12.00	6.00	18.00
	1G4.50.3.7.S	204.7	55.5	37.6	27.8	22440	23	44	51.7	21.3	48.3	26.9	500	3	2.49	60	15.00	6.00	21.00
	1G6.50.3.7.S	273.0	68.0	46.1	34.2	21300	22	42	68.9	21.3	60.3	26.9	500	3	2.49	60	18.00	6.00	24.00
	1G2.63.3.7.S	204.7	66.3	44.3	33.6	46930	38	69	51.2	21.3	48.3	33.7	630	3	5.7	73	21.60	7.20	28.80
	1G4.63.3.7.S	307.1	94.3	63.1	47.8	43890	36	65	76.8	26.9	60.3	33.7	630	3	5.7	73	25.20	7.20	32.40
	1G6.63.3.7.S	409.5	116.0	77.7	58.9	41120	34	61	102.4	26.9	76.1	33.7	630	3	5.7	73	28.80	7.20	36.00
1G2.80.3.7.S	327.6	99.5	66.5	50.0	63300	47	80	81.7	26.9	60.3	42.4	800	3	5.4	62	33.60	14.40	48.00	
1G4.80.3.7.S	491.4	140.0	93.7	70.6	58940	44	75	122.5	33.7	76.1	42.4	800	3	5.4	62	38.40	14.40	52.80	
1G6.80.3.7.S	655.2	170.3	114.2	86.2	55070	41	70	163.4	33.7	88.9	42.4	800	3	5.4	62	43.20	14.40	57.60	
	x 4																		
	1G2.40.4.7.S	73.9	21.0	13.8	10.4	13020	15	32	18.7	21.3	33.7	26.9	400	4	0.64	58	5.20	2.60	7.80
	1G4.40.4.7.S	110.9	29.1	19.9	14.5	11510	13	28	28.6	21.3	42.4	26.9	400	4	0.64	58	7.80	2.60	10.40
	1G6.40.4.7.S	147.9	35.1	23.8	17.7	10450	12	26	37.8	21.3	42.4	26.9	400	4	0.64	58	10.40	2.60	13.00
	1G2.45.4.7.S	109.2	33.6	22.6	16.8	21730	20	45	27.5	21.3	42.4	26.9	450	4	1.96	52	9.60	3.20	12.80
	1G4.45.4.7.S	163.8	47.0	31.6	23.8	20000	18	41	41.3	21.3	42.4	26.9	450	4	1.96	52	12.80	3.20	16.00
	1G6.45.4.7.S	218.4	56.9	38.3	28.8	18430	17	38	55.1	21.3	48.3	26.9	450	4	1.96	52	16.00	3.20	19.20
	1G2.50.4.7.S	182.0	52.6	34.9	26.4	31740	26	49	45.5	21.3	48.3	26.9	500	4	3.32	61	16.00	8.00	24.00
	1G4.50.4.7.S	273.0	73.9	49.0	37.2	29920	24	46	68.2	21.3	60.3	26.9	500	4	3.32	61	20.00	8.00	28.00
	1G6.50.4.7.S	364.0	89.9	59.9	45.3	28400	23	44	91.0	26.9	60.3	26.9	500	4	3.32	61	24.00	8.00	32.00
	1G2.63.4.7.S	273.0	86.6	58.9	43.1	62570	40	72	68.2	26.9	60.3	33.7	630	4	7.6	74	28.80	9.60	38.40
	1G4.63.4.7.S	409.5	123.9	84.1	61.9	58510	37	67	102.3	33.7	76.1	33.7	630	4	7.6	74	33.60	9.60	43.20
	1G6.63.4.7.S	546.0	153.5	104.2	77.1	54830	35	63	136.4	33.7	88.9	33.7	630	4	7.6	74	38.40	9.60	

NES • 7 mm Düşük Hızlı • Low Speed
KAPASİTE TABLOSU / CAPACITY TABLE





MODEL MODEL	Yüzey Surface	Kapasite Capacity				Hava Debisi Air Flow	Üfleme Mesafesi* Air Th row*	Akış kuvvetlendiricili with Streamer	Boru Hacmi Tube Volume	Bağlantılar Connections			Fanlar Fans			Defrost Isıtıcılar Electric Defrost			
		SC1	SC2	SC3	SC4					Giriş Inlet	Çıkış Outlet	Sıcak Gaz Giriş-Çıkış Hot Gas Inlet-Outlet	Fanlar Fans	Sayısı Number	Güç Power	Ses Basıncı Seviyesi Sound Pressure Level	Batarya Coil	Tava D.Tray	Toplam Güç Total Power
		DT=10 K Te=0°C	DT=8 K Te=-8°C	DT=7 K Te=-25°C	DT=6 K Te=-31°C														
m ²	kW	kW	kW	kW	m ³ /h	m	m	dm ³	mm	mm	mm	mm	n	kW	(3m)dB(A)	kW	kW	kW	
x 1	1G2.40.1.7.L	18.5	4.4	2.9	2.2	2260	9	18	6.0	21.3	21.3	21.3	400	1	0.12	39	1.30	0.65	1.95
	1G4.40.1.7.L	27.7	6.2	4.1	3.0	2010	8	16	10.0	21.3	21.3	21.3	400	1	0.12	39	1.95	0.65	2.60
	1G6.40.1.7.L	37.0	7.1	4.9	3.6	1840	7	15	14.8	21.3	21.3	21.3	400	1	0.12	39	2.60	0.65	3.25
	1G2.45.1.7.L	27.3	7.0	4.6	3.5	3580	11	25	8.4	21.3	21.3	21.3	450	1	0.19	38	2.40	0.80	3.20
	1G4.45.1.7.L	40.9	9.3	6.2	4.5	3220	10	22	12.0	21.3	33.7	21.3	450	1	0.19	38	3.20	0.80	4.00
	1G6.45.1.7.L	54.6	10.9	7.3	5.5	2900	9	20	16.9	21.3	33.7	21.3	450	1	0.19	38	4.00	0.80	4.80
	1G2.50.1.7.L	45.5	10.8	7.1	5.3	5150	14	26	12.4	21.3	33.7	21.3	500	1	0.29	45	4.00	2.00	6.00
	1G4.50.1.7.L	68.2	14.9	10.0	7.5	4820	13	25	19.5	21.3	33.7	21.3	500	1	0.29	45	5.00	2.00	7.00
	1G6.50.1.7.L	91.0	17.3	11.6	8.6	4540	12	23	24.8	21.3	33.7	21.3	500	1	0.29	45	6.00	2.00	8.00
	1G2.63.1.7.L	68.2	17.3	11.1	8.3	9560	20	37	17.6	21.3	33.7	21.3	630	1	0.63	52	7.20	2.40	9.60
1G4.63.1.7.L	102.4	25.1	16.6	12.5	9010	19	35	27.0	21.3	42.4	21.3	630	1	0.63	52	8.40	2.40	10.80	
1G6.63.1.7.L	136.5	30.2	20.4	15.1	8540	18	33	36.7	21.3	42.4	21.3	630	1	0.63	52	9.60	2.40	12.00	
x 2	1G2.40.2.7.L	37.0	8.9	5.8	4.3	4520	10	20	9.9	21.3	33.7	21.3	400	2	0.24	42	2.60	1.30	3.90
	1G4.40.2.7.L	55.5	12.3	8.2	6.2	4010	9	18	15.3	21.3	33.7	21.3	400	2	0.24	42	3.90	1.30	5.20
	1G6.40.2.7.L	73.9	14.4	9.7	7.1	3670	8	17	21.1	21.3	33.7	21.3	400	2	0.24	42	5.20	1.30	6.50
	1G2.45.2.7.L	54.6	14.0	9.4	7.0	7150	12	27	14.4	21.3	33.7	21.3	450	2	0.38	41	4.80	1.60	6.40
	1G4.45.2.7.L	81.9	19.0	12.7	9.5	6430	11	24	21.6	21.3	33.7	21.3	450	2	0.38	41	6.40	1.60	8.00
	1G6.45.2.7.L	109.2	21.9	14.7	11.0	5800	10	22	28.8	21.3	42.4	21.3	450	2	0.38	41	8.00	1.60	9.60
	1G2.50.2.7.L	91.0	21.7	14.3	10.7	10300	15	29	23.1	21.3	33.7	21.3	500	2	0.58	48	8.00	4.00	12.00
	1G4.50.2.7.L	136.5	30.0	20.2	15.0	9640	14	27	35.1	21.3	42.4	21.3	500	2	0.58	48	10.00	4.00	14.00
	1G6.50.2.7.L	182.0	34.7	23.1	17.2	9080	13	26	46.3	21.3	42.4	21.3	500	2	0.58	48	12.00	4.00	16.00
	1G2.63.2.7.L	136.5	36.1	24.2	17.9	19120	22	40	34.6	21.3	42.4	26.9	630	2	1.26	55	14.40	4.80	19.20
1G4.63.2.7.L	204.7	50.2	33.8	25.1	18010	21	38	51.9	21.3	48.3	26.9	630	2	1.26	55	16.80	4.80	21.60	
1G6.63.2.7.L	273.0	60.6	40.9	30.5	17080	20	36	69.2	21.3	60.3	26.9	630	2	1.26	55	19.20	4.80	24.00	
x 3	1G2.40.3.7.L	55.5	13.8	9.3	6.9	6770	10	21	14.5	21.3	33.7	21.3	400	3	0.36	44	3.90	1.95	5.85
	1G4.40.3.7.L	83.2	18.5	12.4	9.3	6010	9	19	21.7	21.3	33.7	21.3	400	3	0.36	44	5.85	1.95	7.80
	1G6.40.3.7.L	110.9	21.4	14.4	10.8	5510	8	17	28.9	21.3	33.7	21.3	400	3	0.36	44	7.80	1.95	9.75
	1G2.45.3.7.L	81.9	21.2	14.1	10.6	10730	12	28	20.9	21.3	33.7	26.9	450	3	0.57	43	7.20	2.40	9.60
	1G4.45.3.7.L	122.8	28.6	19.2	14.4	9650	11	25	31.4	21.3	42.4	26.9	450	3	0.57	43	9.60	2.40	12.00
	1G6.45.3.7.L	163.8	32.9	22.1	16.5	8690	10	23	41.8	21.3	42.4	26.9	450	3	0.57	43	12.00	2.40	14.40
	1G2.50.3.7.L	136.5	32.9	22.1	16.3	15450	16	30	34.5	21.3	42.4	26.9	500	3	0.87	50	12.00	6.00	18.00
	1G4.50.3.7.L	204.7	45.0	30.3	22.5	14460	15	28	51.7	21.3	48.3	26.9	500	3	0.87	50	15.00	6.00	21.00
	1G6.50.3.7.L	273.0	53.2	36.0	26.8	13620	14	27	68.9	21.3	60.3	26.9	500	3	0.87	50	18.00	6.00	24.00
	1G2.63.3.7.L	204.7	54.3	36.0	27.1	28680	23	42	51.2	21.3	48.3	33.7	630	3	1.89	57	21.60	7.20	28.80
1G4.63.3.7.L	307.1	75.3	50.1	37.7	27020	22	40	76.8	26.9	60.3	33.7	630	3	1.89	57	25.20	7.20	32.40	
1G6.63.3.7.L	409.5	90.3	60.3	45.4	25610	21	38	102.4	26.9	76.1	33.7	630	3	1.89	57	28.80	7.20	36.00	
x 4	1G2.40.4.7.L	73.9	17.8	11.7	8.6	9030	11	22	18.7	21.3	33.7	26.9	400	4	0.48	45	5.20	2.60	7.80
	1G4.40.4.7.L	110.9	24.6	16.6	12.2	8020	9	20	28.6	21.3	42.4	26.9	400	4	0.48	45	7.80	2.60	10.40
	1G6.40.4.7.L	147.9	28.6	19.3	14.4	7340	9	18	37.8	21.3	42.4	26.9	400	4	0.48	45	10.40	2.60	13.00
	1G2.45.4.7.L	109.2	28.2	18.9	14.0	14320	13	30	27.5	21.3	42.4	26.9	450	4	0.76	44	9.60	3.20	12.80
	1G4.45.4.7.L	163.8	38.0	25.5	19.0	12880	12	27	41.3	21.3	42.4	26.9	450	4	0.76	44	12.80	3.20	16.00
	1G6.45.4.7.L	218.4	44.0	29.5	22.0	11590	10	24	55.1	21.3	48.3	26.9	450	4	0.76	44	16.00	3.20	19.20
	1G2.50.4.7.L	182.0	43.4	28.6	21.4	20600	17	32	45.5	21.3	48.3	26.9	500	4	1.16	51	16.00	8.00	24.00
	1G4.50.4.7.L	273.0	59.0	39.1	29.3	19280	16	30	68.2	21.3	60.3	26.9	500	4	1.16	51	20.00	8.00	28.00
	1G6.50.4.7.L	364.0	69.3	46.1	34.5	18150	15	28	91.0	26.9	60.3	26.9	500	4	1.16	51	24.00	8.00	32.00
	1G2.63.4.7.L	273.0	72.3	48.6	35.9	38240	24	44	68.2	26.9	60.3	33.7	630	4	2.52	58	28.80	9.60	38.40
1G4.63.4.7.L	409.5	100.5	67.7	50.3	36020	23	42	102.3	33.7	76.1	33.7	630	4	2.52	58	33.60	9.60	43.20	
1G6.63.4.7.L	546.0	121.3	81.9	61.0	34150	22	39	136.4	33.7	88.9	33.7	630	4	2.52	58	38.40	9.60	48.00	

*Katalogta verilen üfleme mesafesi değerleri ideal durum içindir. Fanların üfleme performansı çalışma koşullarına bağlı olarak (oda içi yerleşim, hava sıcaklığı, kar kalınlığı vb.) değişkenlik gösterir.

*The indicated air throws are valid for ideal conditions. Fans' air throw performance may vary because of the surrounding conditions such as spatial dimensions, installation, air cooling, frost formation.

NES • 10 mm

KAPASİTE TABLOSU / CAPACITY TABLE

MODEL MODEL	Yüzey Surface	Kapasite Capacity				Hava Debisi Air Flow	Üfleme Mesafesi* Air Th row*	Akış kuvvetlendiricili with Streamer	Boru Hacmi Tube Volume	Bağlantılar Connections			Fanlar Fans				Defrost Isıtıcılar Electric Defrost		
		SC1	SC2	SC3	SC4					Giriş Inlet	Çıkış Outlet	Sıcak Gaz Giriş-Çıkış Hot Gas Inlet-Outlet	Fanlar Fans	Sayısı Number	Güç Power	Ses Basınç Seviyesi Sound Pressure Level	Batarya Coil	Tava D.Tray	Toplam Güç Total Power
		DT=10 K Te=0°C	DT=8 K Te=-8°C	DT=7 K Te=-25°C	DT=6 K Te=-31°C														
m ²	kW	kW	kW	kW	m ³ /h	m	m	dm ³	mm	mm	mm	mm	n	kW	(3m)dB(A)	kW	kW	kW	
 x 1	1G2.40.1.10.S	13.3	2.9	2.2	1.7	3390	13	28	6.0	21.3	21.3	21.3	400	1	0.16	52	1.30	0.65	1.95
	1G4.40.1.10.S	20.0	4.2	3.2	2.6	3080	12	25	10.0	21.3	21.3	21.3	400	1	0.16	52	1.95	0.65	2.60
	1G6.40.1.10.S	26.6	5.2	3.8	3.1	2820	11	23	14.8	21.3	21.3	21.3	400	1	0.16	52	2.60	0.65	3.25
	1G2.45.1.10.S	19.7	4.6	3.5	2.9	5600	17	38	8.4	21.3	21.3	21.3	450	1	0.49	46	2.40	0.80	3.20
	1G4.45.1.10.S	29.5	6.5	4.7	3.8	5230	16	36	13.9	21.3	21.3	21.3	450	1	0.49	46	3.20	0.80	4.00
	1G6.45.1.10.S	39.3	8.2	6.2	5.0	4890	15	34	16.9	21.3	33.7	21.3	450	1	0.49	46	4.00	0.80	4.80
	1G2.50.1.10.S	32.8	7.2	5.5	4.4	8090	22	41	12.4	21.3	33.7	21.3	500	1	0.83	55	4.00	2.00	6.00
	1G4.50.1.10.S	49.1	10.5	7.8	6.3	7710	21	39	19.5	21.3	33.7	21.3	500	1	0.83	55	5.00	2.00	7.00
	1G6.50.1.10.S	65.5	12.8	9.6	7.7	7370	20	38	24.8	21.3	33.7	21.3	500	1	0.83	55	6.00	2.00	8.00
	1G2.63.1.10.S	49.1	12.3	9.1	7.4	16060	34	62	18.3	21.3	33.7	21.3	630	1	1.9	68	7.20	2.40	9.60
	1G4.63.1.10.S	73.7	17.6	13.1	10.6	15190	32	58	27.5	21.3	33.7	21.3	630	1	1.9	68	8.40	2.40	10.80
	1G6.63.1.10.S	98.3	22.4	16.7	13.5	14400	31	55	36.7	21.3	42.4	21.3	630	1	1.9	68	9.60	2.40	12.00
1G2.80.1.10.S	78.6	18.2	13.9	11.3	21670	42	72	28.0	21.3	42.4	26.9	800	1	1.8	57	11.20	4.80	16.00	
1G4.80.1.10.S	117.9	26.0	19.8	16.1	20460	40	68	41.9	21.3	42.4	26.9	800	1	1.8	57	12.80	4.80	17.60	
1G6.80.1.10.S	157.2	32.5	24.7	20.1	19330	38	64	55.9	21.3	48.3	26.9	800	1	1.8	57	14.40	4.80	19.20	
 x 2	1G2.40.2.10.S	26.6	6.1	4.4	3.6	6770	15	30	10.6	21.3	21.3	21.3	400	2	0.32	55	2.60	1.30	3.90
	1G4.40.2.10.S	39.9	8.4	6.3	5.2	6160	13	28	15.3	21.3	33.7	21.3	400	2	0.32	55	3.90	1.30	5.20
	1G6.40.2.10.S	53.2	10.4	7.7	6.3	5630	12	25	21.1	21.3	33.7	21.3	400	2	0.32	55	5.20	1.30	6.50
	1G2.45.2.10.S	39.3	9.4	7.1	5.8	11200	18	42	14.4	21.3	33.7	21.3	450	2	0.98	49	4.80	1.60	6.40
	1G4.45.2.10.S	59.0	13.3	10.0	8.1	10450	17	40	21.6	21.3	33.7	21.3	450	2	0.98	49	6.40	1.60	8.00
	1G6.45.2.10.S	78.6	16.5	12.5	10.1	9780	16	37	28.8	21.3	33.7	21.3	450	2	0.98	49	8.00	1.60	9.60
	1G2.50.2.10.S	65.5	14.3	10.8	8.8	16180	24	45	23.1	21.3	33.7	21.3	500	2	1.66	58	8.00	4.00	12.00
	1G4.50.2.10.S	98.3	21.0	15.7	12.8	15420	23	43	35.1	21.3	42.4	21.3	500	2	1.66	58	10.00	4.00	14.00
	1G6.50.2.10.S	131.0	25.4	19.3	15.6	14730	22	41	46.3	21.3	42.4	21.3	500	2	1.66	58	12.00	4.00	16.00
	1G2.63.2.10.S	98.3	24.6	18.3	14.8	32120	38	68	34.6	21.3	42.4	26.9	630	2	3.8	71	14.40	4.80	19.20
	1G4.63.2.10.S	147.4	35.3	26.4	21.4	30370	36	64	51.9	21.3	48.3	26.9	630	2	3.8	71	16.80	4.80	21.60
	1G6.63.2.10.S	196.5	44.7	33.5	27.2	28800	34	61	69.2	21.3	48.3	26.9	630	2	3.8	71	19.20	4.80	24.00
1G2.80.2.10.S	157.2	36.6	27.9	22.8	43330	46	79	54.7	21.3	48.3	33.7	800	2	3.6	60	22.40	9.60	32.00	
1G4.80.2.10.S	235.8	52.0	39.7	32.2	40910	44	74	82.0	26.9	60.3	33.7	800	2	3.6	60	25.60	9.60	35.20	
1G6.80.2.10.S	314.4	65.1	49.5	40.4	38650	41	70	109.4	26.9	60.3	33.7	800	2	3.6	60	28.80	9.60	38.4	
 x 3	1G2.40.3.10.S	39.9	9.1	6.8	5.6	10160	15	32	14.5	21.3	33.7	21.3	400	3	0.48	57	3.90	1.95	5.85
	1G4.40.3.10.S	59.9	12.7	9.5	7.7	9230	14	29	21.7	21.3	33.7	21.3	400	3	0.48	57	5.85	1.95	7.80
	1G6.40.3.10.S	79.8	15.5	11.6	9.5	8450	13	27	28.9	21.3	33.7	21.3	400	3	0.48	57	7.80	1.95	9.75
	1G2.45.3.10.S	59.0	14.1	10.6	8.7	16800	19	44	20.9	21.3	33.7	26.9	450	3	1.47	51	7.20	2.40	9.60
	1G4.45.3.10.S	88.4	20.1	15.0	12.3	15680	18	41	31.4	21.3	42.4	26.9	450	3	1.47	51	9.60	2.40	12.00
	1G6.45.3.10.S	117.9	24.8	18.7	15.2	14670	17	39	41.8	21.3	42.4	26.9	450	3	1.47	51	12.00	2.40	14.40
	1G2.50.3.10.S	98.3	22.1	16.5	13.4	24270	25	48	34.5	21.3	42.4	26.9	500	3	2.49	60	12.00	6.00	18.00
	1G4.50.3.10.S	147.4	31.5	23.5	19.2	23120	24	45	51.7	21.3	42.4	26.9	500	3	2.49	60	15.00	6.00	21.00
	1G6.50.3.10.S	196.5	39.6	29.6	24.1	22100	23	43	68.9	21.3	48.3	26.9	500	3	2.49	60	18.00	6.00	24.00
	1G2.63.3.10.S	147.4	36.7	28.1	22.9	48170	39	71	51.2	21.3	48.3	33.7	630	3	5.7	73	21.60	7.20	28.80
	1G4.63.3.10.S	221.1	52.5	40.2	32.7	45550	37	67	76.8	26.9	60.3	33.7	630	3	5.7	73	25.20	7.20	32.40
	1G6.63.3.10.S	294.8	66.3	50.7	41.2	43200	35	64	102.4	26.9	60.3	33.7	630	3	5.7	73	28.80	7.20	36.00
1G2.80.3.10.S	235.8	54.9	41.8	34.1	64990	49	82	81.7	26.9	60.3	42.4	800	3	5.4	62	33.60	14.40	48.00	
1G4.80.3.10.S	353.7	78.1	59.4	48.5	61360	46	78	122.5	26.9	76.1	42.4	800	3	5.4	62	38.40	14.40	52.80	
1G6.80.3.10.S	471.7	97.7	74.4	60.6	57980	43	74	163.4	33.7	76.1	42.4	800	3	5.4	62	43.20	14.40	57.60	
 x 4	1G2.40.4.10.S	53.2	12.2	9.0	7.2	13550	16	33	19.0	21.3	33.7	26.9	400	4	0.64	58	5.20	2.60	7.80
	1G4.40.4.10.S	79.8	17.0	12.6	10.2	12310	14	30	28.6	21.3	33.7	26.9	400	4	0.64	58	7.80	2.60	10.40
	1G6.40.4.10.S	106.5	20.9	15.5	12.6	11270	13	28	38.1	21.3	42.4	26.9	400	4	0.64	58	10.40	2.60	13.00
	1G2.45.4.10.S	78.6	18.7	14.1	11.5	22400	20	46	27.5	21.3	42.4	26.9	450	4	1.96	52	9.60	3.20	12.80
	1G4.45.4.10.S	117.9	26.6	20.1	16.3	20900	19	43	41.3	21.3	42.4	26.9	450	4	1.96	52	12.80	3.20	16.00
	1G6.45.4.10.S	157.2	33.1	24.9	20.3	19550	18	40	55.1	21.3	48.3	26.9	450	4	1.96	52	16.00	3.20	19.20
	1G2.50.4.10.S	131.0	28.7	21.7	17.6	32350	26	50	45.5	21.3	42.4	26.9	500	4	3.32	61	16.00	8.00	24.00
	1G4.50.4.10.S	196.5	40.8	30.8	24.9	30830	25	47	68.2	21.3	48.3	26.9	500	4	3.32	61	20.00	8.00	28.00
	1G6.50.4.10.S	262.0	51.0	38.5	31.1	29460	24	45	91.0	21.3	60.3	26.9	500	4	3.32	61	24.00	8.00	32.00
	1G2.63.4.10.S	196.5	49.3	36.8	29.9	64230	41	74	68.2	21.3	60.3	33.7	630	4	7.6	74	28.80	9.60	38.40
	1G4.63.4.10.S	294.8	70.8	52.9	43.1	60730	39	70	102.3	26.9	76.1	33.7	630	4	7.6	74	33.60	9.60	43.20
	1G6.63.4.10.S	393.0	89.6	67.2	54.7	57590	37	66	136.4	33.7	76.1	33.7	630	4	7.6	74	38.40	9.60	48.00
1G2.80.4.10.S	314.4	73.4	54.6	44.3	86660	51	86	108.											

NES • 10 mm Düşük Hızlı • Low Speed

KAPASİTE TABLOSU / CAPACITY TABLE





MODEL MODEL	Yüzey Surface	Kapasite Capacity				Hava Debisi Air Flow	Üfleme Mesafesi* Air Th row*	Akış kuvvetlendiricili with Streamer	Boru Hacmi Tube Volume	Bağlantılar Connections			Fanlar Fans			Defrost Isıtıcılar Electric Defrost			
		SC1	SC2	SC3	SC4					Giriş Inlet	Çıkış Outlet	Soğuk Gaz Giriş-Çıkış Hot Gas Inlet-Outlet	Fanlar Fans	Sayısı Number	Güç Power	Ses Basınç Seviyesi Sound Pressure Level	Batarya Coil	Tava D.Tray	Toplam Güç Total Power
		DT=10 K Te=0°C	DT=8 K Te=-8°C	DT=7 K Te=-25°C	DT=6 K Te=-31°C														
	m ²	kW	kW	kW	kW	m ³ /h	m	m	dm ³	mm	mm	mm	mm	n	kW	(3m)dB(A)	kW	kW	kW
x 1	1G2.40.1.10.L	13.3	2.5	1.8	1.4	2430	9	20	6.0	21.3	21.3	21.3	400	1	0.12	39	1.30	0.65	1.95
	1G4.40.1.10.L	20.0	3.5	2.6	2.2	2130	8	17	10.0	21.3	21.3	21.3	400	1	0.12	39	1.95	0.65	2.60
	1G6.40.1.10.L	26.6	4.3	3.2	2.6	1970	8	16	14.8	21.3	21.3	21.3	400	1	0.12	39	2.60	0.65	3.25
	1G2.45.1.10.L	19.7	3.9	2.9	2.4	3740	11	26	8.4	21.3	21.3	21.3	450	1	0.19	38	2.40	0.80	3.20
	1G4.45.1.10.L	29.5	5.5	3.9	3.2	3420	10	24	13.9	21.3	21.3	21.3	450	1	0.19	38	3.20	0.80	4.00
	1G6.45.1.10.L	39.3	6.5	4.8	3.9	3100	9	21	16.9	21.3	33.7	21.3	450	1	0.19	38	4.00	0.80	4.80
	1G2.50.1.10.L	32.8	5.9	4.3	3.5	5250	14	27	12.4	21.3	33.7	21.3	500	1	0.29	45	4.00	2.00	6.00
	1G4.50.1.10.L	49.1	8.4	6.3	5.2	4960	13	25	19.5	21.3	33.7	21.3	500	1	0.29	45	5.00	2.00	7.00
	1G6.50.1.10.L	65.5	9.9	7.4	5.9	4730	13	24	24.8	21.3	33.7	21.3	500	1	0.29	45	6.00	2.00	8.00
	1G2.63.1.10.L	49.1	10.0	7.5	6.1	9780	21	38	18.3	21.3	33.7	21.3	630	1	0.63	52	7.20	2.40	9.60
	1G4.63.1.10.L	73.7	14.1	10.5	8.7	9310	20	36	27.5	21.3	33.7	21.3	630	1	0.63	52	8.40	2.40	10.80
1G6.63.1.10.L	98.3	17.6	13.1	10.7	8880	19	34	36.7	21.3	42.4	21.3	630	1	0.63	52	9.60	2.40	12.00	
x 2	1G2.40.2.10.L	26.6	5.3	3.9	3.2	4850	10	22	10.6	21.3	21.3	21.3	400	2	0.24	42	2.60	1.30	3.90
	1G4.40.2.10.L	39.9	7.0	5.3	4.2	4260	9	19	15.3	21.3	33.7	21.3	400	2	0.24	42	3.90	1.30	5.20
	1G6.40.2.10.L	53.2	8.5	6.4	5.2	3940	8	18	21.1	21.3	33.7	21.3	400	2	0.24	42	5.20	1.30	6.50
	1G2.45.2.10.L	39.3	7.8	5.9	4.7	7470	12	28	14.4	21.3	33.7	21.3	450	2	0.38	41	4.80	1.60	6.40
	1G4.45.2.10.L	59.0	10.8	8.0	6.6	6830	11	26	21.6	21.3	33.7	21.3	450	2	0.38	41	6.40	1.60	8.00
	1G6.45.2.10.L	78.6	12.9	9.7	7.8	6200	10	23	28.8	21.3	33.7	21.3	450	2	0.38	41	8.00	1.60	9.60
	1G2.50.2.10.L	65.5	11.7	8.8	7.0	10490	16	30	23.1	21.3	33.7	21.3	500	2	0.58	48	8.00	4.00	12.00
	1G4.50.2.10.L	98.3	16.9	12.6	10.3	9920	15	28	35.1	21.3	42.4	21.3	500	2	0.58	48	10.00	4.00	14.00
	1G6.50.2.10.L	131.0	19.9	14.7	11.7	9450	14	27	46.3	21.3	42.4	21.3	500	2	0.58	48	12.00	4.00	16.00
	1G2.63.2.10.L	98.3	20.1	15.0	12.3	19550	23	41	34.6	21.3	42.4	26.9	630	2	1.26	55	14.40	4.80	19.20
	1G4.63.2.10.L	147.4	28.3	21.2	17.3	18610	22	39	51.9	21.3	48.3	26.9	630	2	1.26	55	16.80	4.80	21.60
1G6.63.2.10.L	196.5	35.2	26.4	21.5	17760	21	38	69.2	21.3	48.3	26.9	630	2	1.26	55	19.20	4.80	24.00	
x 3	1G2.40.3.10.L	39.9	7.8	5.9	4.7	7280	11	23	14.5	21.3	33.7	21.3	400	3	0.36	44	3.90	1.95	5.85
	1G4.40.3.10.L	59.9	10.5	7.8	6.4	6390	10	20	21.7	21.3	33.7	21.3	400	3	0.36	44	5.85	1.95	7.80
	1G6.40.3.10.L	79.8	12.7	9.5	7.6	5910	9	19	28.9	21.3	33.7	21.3	400	3	0.36	44	7.80	1.95	9.75
	1G2.45.3.10.L	59.0	11.7	8.9	7.2	11220	13	30	20.9	21.3	33.7	26.9	450	3	0.57	43	7.20	2.40	9.60
	1G4.45.3.10.L	88.4	16.4	12.2	10.0	10250	12	27	31.4	21.3	42.4	26.9	450	3	0.57	43	9.60	2.40	12.00
	1G6.45.3.10.L	117.9	19.4	14.4	11.7	9290	11	25	41.8	21.3	42.4	26.9	450	3	0.57	43	12.00	2.40	14.40
	1G2.50.3.10.L	98.3	18.3	13.6	11.1	15730	16	31	34.5	21.3	42.4	26.9	500	3	0.87	50	12.00	6.00	18.00
	1G4.50.3.10.L	147.4	25.4	19.0	15.5	14880	15	29	51.7	21.3	42.4	26.9	500	3	0.87	50	15.00	6.00	21.00
	1G6.50.3.10.L	196.5	31.1	23.2	19.0	14180	15	28	68.9	21.3	48.3	26.9	500	3	0.87	50	18.00	6.00	24.00
	1G2.63.3.10.L	147.4	29.7	22.4	18.2	29320	24	43	51.2	21.3	48.3	33.7	630	3	1.89	57	21.60	7.20	28.80
	1G4.63.3.10.L	221.1	41.7	31.4	25.5	27910	23	41	76.8	26.9	60.3	33.7	630	3	1.89	57	25.20	7.20	32.40
1G6.63.3.10.L	294.8	51.6	38.9	31.5	26630	22	39	102.4	26.9	60.3	33.7	630	3	1.89	57	28.80	7.20	36.00	
x 4	1G2.40.4.10.L	53.2	10.6	7.8	6.3	9720	11	24	19.0	21.3	33.7	26.9	400	4	0.48	45	5.20	2.60	7.80
	1G4.40.4.10.L	79.8	14.2	10.5	8.5	8520	10	21	28.6	21.3	33.7	26.9	400	4	0.48	45	7.80	2.60	10.40
	1G6.40.4.10.L	106.5	17.2	12.8	10.4	7880	9	19	38.1	21.3	42.4	26.9	400	4	0.48	45	10.40	2.60	13.00
	1G2.45.4.10.L	78.6	15.7	11.7	9.6	14960	13	31	27.5	21.3	42.4	26.9	450	4	0.76	44	9.60	3.20	12.80
	1G4.45.4.10.L	117.9	21.5	16.2	13.2	13680	12	28	41.3	21.3	42.4	26.9	450	4	0.76	44	12.80	3.20	16.00
	1G6.45.4.10.L	157.2	25.8	19.3	15.7	12390	11	26	55.1	21.3	48.3	26.9	450	4	0.76	44	16.00	3.20	19.20
	1G2.50.4.10.L	131.0	23.5	17.5	14.1	21000	17	32	45.5	21.3	42.4	26.9	500	4	1.16	51	16.00	8.00	24.00
	1G4.50.4.10.L	196.5	32.4	24.2	19.4	19840	16	30	68.2	21.3	48.3	26.9	500	4	1.16	51	20.00	8.00	28.00
	1G6.50.4.10.L	262.0	39.7	29.6	23.6	18900	15	29	91.0	21.3	60.3	26.9	500	4	1.16	51	24.00	8.00	32.00
	1G2.63.4.10.L	196.5	40.3	30.1	24.5	39090	25	45	68.2	21.3	60.3	33.7	630	4	2.52	58	28.80	9.60	38.40
	1G4.63.4.10.L	294.8	56.8	42.4	34.6	37210	24	43	102.3	26.9	76.1	33.7	630	4	2.52	58	33.60	9.60	43.20
1G6.63.4.10.L	393.0	70.5	52.7	43.1	35510	23	41	136.4	33.7	76.1	33.7	630	4	2.52	58	38.40	9.60	48.00	

*Katalogta verilen üfleme mesafesi değerleri ideal durum içindir. Fanların üfleme performansı çalışma koşullarına bağlı olarak (oda içi yerleşim, hava sıcaklığı, kar kalınlığı vb.) değişiklik gösterir.

*The indicated air throws are valid for ideal conditions. Fans' air throw performance may vary because of the surrounding conditions such as spatial dimensions, installation, air cooling, frost formation.





NES • 12 mm

KAPASİTE TABLOSU / CAPACITY TABLE

MODEL MODEL	Yüzey Surface	Kapasite Capacity				Hava Debisi Air Flow	Üfleme Mesafesi* Air Th row*	Akış kuvvetlendiricili with Streamer	Boru Hacmi Tube Volume	Bağlantılar Connections			Fanlar Fans				Defrost Isıtıcılar Electric Defrost		
		SC1	SC2	SC3	SC4					Giriş Inlet	Çıkış Outlet	Sıcak Gaz Giriş-Çıkış Hot Gas Inlet-Outlet	Fanlar Fans	Sayı Number	Güç Power	Ses Basıncı Seviyesi Sound Pressure Level	Batarya Coil	Tava D.Tray	Toplam Güç Total Power
	m ²	kW	kW	kW	kW	m ³ /h	m	m	dm ³	mm	mm	mm	mm	n	kW	(3m)dB(A)	kW	kW	kW
 x 1	1G2.40.1.12.S	11.3	2.6	1.9	1.5	3460	13	28	6.0	21.3	21.3	21.3	400	1	0.16	52	1.30	0.65	1.95
	1G4.40.1.12.S	16.9	3.8	2.9	2.4	3170	12	26	10.0	21.3	21.3	21.3	400	1	0.16	52	1.95	0.65	2.60
	1G6.40.1.12.S	22.6	4.8	3.5	2.9	2900	11	24	14.8	21.3	21.3	21.3	400	1	0.16	52	2.60	0.65	3.25
	1G2.45.1.12.S	16.7	4.2	3.2	2.6	5680	17	39	8.4	21.3	21.3	21.3	450	1	0.49	46	2.40	0.80	3.20
	1G4.45.1.12.S	25.0	6.0	4.3	3.5	5340	16	37	13.9	21.3	21.3	21.3	450	1	0.49	46	3.20	0.80	4.00
	1G6.45.1.12.S	33.4	7.5	5.7	4.6	5000	15	34	16.9	21.3	33.7	21.3	450	1	0.49	46	4.00	0.80	4.80
	1G2.50.1.12.S	27.8	6.4	4.8	3.9	8170	22	42	12.4	21.3	33.7	21.3	500	1	0.83	55	4.00	2.00	6.00
	1G4.50.1.12.S	41.7	9.5	7.1	5.8	7830	21	40	19.5	21.3	33.7	21.3	500	1	0.83	55	5.00	2.00	7.00
	1G6.50.1.12.S	55.6	11.6	8.8	7.1	7520	20	38	24.8	21.3	33.7	21.3	500	1	0.83	55	6.00	2.00	8.00
	1G2.63.1.12.S	41.7	11.1	8.3	6.8	16200	35	62	18.3	21.3	33.7	21.3	630	1	1.9	68	7.20	2.40	9.60
	1G4.63.1.12.S	62.5	16.0	12.1	9.8	15420	33	59	27.5	21.3	33.7	21.3	630	1	1.9	68	8.40	2.40	10.80
	1G6.63.1.12.S	83.4	20.4	15.5	12.6	14680	31	56	36.7	21.3	42.4	21.3	630	1	1.9	68	9.60	2.40	12.00
	1G2.80.1.12.S	66.7	16.4	12.6	10.3	21910	43	72	28.0	21.3	33.7	26.9	800	1	1.8	57	11.20	4.80	16.00
1G4.80.1.12.S	100.1	23.4	17.9	14.6	20780	40	69	41.9	21.3	42.4	26.9	800	1	1.8	57	12.80	4.80	17.60	
1G6.80.1.12.S	133.4	29.8	22.7	18.5	19730	38	65	55.9	21.3	42.4	26.9	800	1	1.8	57	14.40	4.80	19.20	
 x 2	1G2.40.2.12.S	22.6	5.6	4.1	3.3	6910	15	31	10.6	21.3	21.3	21.3	400	2	0.32	55	2.60	1.30	3.90
	1G4.40.2.12.S	33.9	7.6	5.8	4.7	6330	14	29	15.3	21.3	33.7	21.3	400	2	0.32	55	3.90	1.30	5.20
	1G6.40.2.12.S	45.2	9.7	7.1	5.9	5800	12	26	21.1	21.3	33.7	21.3	400	2	0.32	55	5.20	1.30	6.50
	1G2.45.2.12.S	33.4	8.4	6.4	5.3	11350	19	43	14.4	21.3	33.7	21.3	450	2	0.98	49	4.80	1.60	6.40
	1G4.45.2.12.S	50.0	11.9	9.1	7.4	10680	18	40	21.6	21.3	33.7	21.3	450	2	0.98	49	6.40	1.60	8.00
	1G6.45.2.12.S	66.7	15.1	11.4	9.4	10000	16	38	28.8	21.3	33.7	21.3	450	2	0.98	49	8.00	1.60	9.60
	1G2.50.2.12.S	55.6	12.9	9.8	7.9	16330	24	46	23.1	21.3	33.7	21.3	500	2	1.66	58	8.00	4.00	12.00
	1G4.50.2.12.S	83.4	19.1	14.3	11.6	15650	23	44	35.1	21.3	42.4	21.3	500	2	1.66	58	10.00	4.00	14.00
	1G6.50.2.12.S	111.2	23.3	17.6	14.2	15040	22	42	46.3	21.3	42.4	21.3	500	2	1.66	58	12.00	4.00	16.00
	1G2.63.2.12.S	83.4	22.2	16.8	13.7	32390	38	68	34.6	21.3	42.4	26.9	630	2	3.8	71	14.40	4.80	19.20
	1G4.63.2.12.S	125.1	32.0	24.1	19.7	30830	36	65	51.9	21.3	48.3	26.9	630	2	3.8	71	16.80	4.80	21.60
	1G6.63.2.12.S	166.8	41.0	31.0	25.2	29350	34	62	69.2	21.3	48.3	26.9	630	2	3.8	71	19.20	4.80	24.00
	1G2.80.2.12.S	133.4	32.9	25.2	20.6	43820	47	80	54.7	21.3	48.3	33.7	800	2	3.6	60	22.40	9.60	32.00
1G4.80.2.12.S	200.1	46.9	35.8	29.3	41560	44	76	82.0	21.3	60.3	33.7	800	2	3.6	60	25.60	9.60	35.20	
1G6.80.2.12.S	266.9	59.5	45.4	37.1	39460	42	72	109.4	26.9	60.3	33.7	800	2	3.6	60	28.80	9.60	38.40	
 x 3	1G2.40.3.12.S	33.9	8.2	6.2	5.0	10370	15	33	14.5	21.3	33.7	21.3	400	3	0.48	57	3.90	1.95	5.85
	1G4.40.3.12.S	50.8	11.5	8.7	7.1	9500	14	30	21.7	21.3	33.7	21.3	400	3	0.48	57	5.85	1.95	7.80
	1G6.40.3.12.S	67.8	14.2	10.7	8.8	8700	13	27	28.9	21.3	33.7	21.3	400	3	0.48	57	7.80	1.95	9.75
	1G2.45.3.12.S	50.0	12.7	9.6	7.8	17030	20	45	20.9	21.3	33.7	26.9	450	3	1.47	51	7.20	2.40	9.60
	1G4.45.3.12.S	75.1	18.1	13.7	11.2	16020	18	42	31.4	21.3	42.4	26.9	450	3	1.47	51	9.60	2.40	12.00
	1G6.45.3.12.S	100.1	22.7	17.2	14.0	15000	17	40	41.8	21.3	42.4	26.9	450	3	1.47	51	12.00	2.40	14.40
	1G2.50.3.12.S	83.4	20.0	15.0	12.3	24490	25	48	34.5	21.3	42.4	26.9	500	3	2.49	60	12.00	6.00	18.00
	1G4.50.3.12.S	125.1	28.5	21.4	17.5	23470	24	46	51.7	21.3	42.4	26.9	500	3	2.49	60	15.00	6.00	21.00
	1G6.50.3.12.S	166.8	36.4	27.3	22.4	22550	23	44	68.9	21.3	48.3	26.9	500	3	2.49	60	18.00	6.00	24.00
	1G2.63.3.12.S	125.1	33.0	25.3	20.7	48590	40	72	51.2	21.3	48.3	33.7	630	3	5.7	73	21.60	7.20	28.80
	1G4.63.3.12.S	187.6	47.3	36.4	29.7	46240	38	68	76.8	21.3	60.3	33.7	630	3	5.7	73	25.20	7.20	32.40
	1G6.63.3.12.S	250.2	60.5	46.4	37.8	44030	36	65	102.4	26.9	60.3	33.7	630	3	5.7	73	28.80	7.20	36.00
	1G2.80.3.12.S	200.1	49.3	37.8	30.9	65720	49	83	81.7	21.3	60.3	42.4	800	3	5.4	62	33.60	14.40	48.00
1G4.80.3.12.S	300.2	70.3	53.9	44.0	62330	47	79	122.5	26.9	76.1	42.4	800	3	5.4	62	38.40	14.40	52.80	
1G6.80.3.12.S	400.3	89.3	68.2	55.7	59190	44	75	163.4	33.7	76.1	42.4	800	3	5.4	62	43.20	14.40	57.60	
 x 4	1G2.40.4.12.S	45.2	11.1	8.2	6.7	13850	16	34	19.0	21.3	33.7	26.9	400	4	0.64	58	5.20	2.60	7.80
	1G4.40.4.12.S	67.8	15.6	11.5	9.4	12680	15	31	28.6	21.3	33.7	26.9	400	4	0.64	58	7.80	2.60	10.40
	1G6.40.4.12.S	90.3	19.3	14.3	11.7	11600	14	28	38.1	21.3	42.4	26.9	400	4	0.64	58	10.40	2.60	13.00
	1G2.45.4.12.S	66.7	16.9	12.9	10.4	22700	20	47	27.5	21.3	33.7	26.9	450	4	1.96	52	9.60	3.20	12.80
	1G4.45.4.12.S	100.1	24.0	18.2	14.8	21350	19	44	41.3	21.3	42.4	26.9	450	4	1.96	52	12.80	3.20	16.00
	1G6.45.4.12.S	133.4	30.3	23.0	18.6	20000	18	41	55.1	21.3	42.4	26.9	450	4	1.96	52	16.00	3.20	19.20
	1G2.50.4.12.S	111.2	25.8	19.6	15.8	32660	26	50	45.5	21.3	42.4	26.9	500	4	3.32	61	16.00	8.00	24.00
	1G4.50.4.12.S	166.8	36.7	27.8	22.5	31290	25	48	68.2	21.3	48.3	26.9	500	4	3.32	61	20.00	8.00	28.00
	1G6.50.4.12.S	222.4	46.6	35.2	28.4	30070	24	46	91.0	21.3	60.3	26.9	500	4	3.32	61	24.00	8.00	32.00
	1G2.63.4.12.S	166.8	44.5	33.6	27.4	64780	41	75	68.2	21.3	48.3	33.7	630	4	7.6	74	28.80	9.60	38.40
	1G4.63.4.12.S	250.2	64.1	48.4	39.6	61650	39	71	102.3	26.9	60.3	33.7	630	4	7.6	74	33.60	9.60	43.20
	1G6.63.4.12.S	333.6	82.1	62.1	50.7	58700	38	68	136.4	33.7	76.1	33.7	630	4	7.6	74	38.40	9.60	48.00
	1G2.80.4.12.S	266.9	66.5	50.0	40.8	87630	51	87	108.8	26.9	60.3	42.4	800	4	7.2	63	44.80	19.20	64.00
1G4.80.4.12.S	400.3	95.1	71.5	58.4	83110														

NES • 12 mm Düşük Hızlı • Low Speed

KAPASİTE TABLOSU / CAPACITY TABLE

MODEL MODEL	Yüzey Surface	Kapasite Capacity				Hava Debisi Air Flow	Üfleme Mesafesi* Air Th row*	Akış kuvvetlendiricili with Streamer	Boru Hacmi Tube Volume	Bağlantılar Connections			Fanlar Fans			Defrost Isıtıcılar Electric Defrost			
		SC1	SC2	SC3	SC4					Giriş Inlet	Çıkış Outlet	Sıcak Gaz Giriş-Çıkış Hot Gas Inlet-Outlet	Fanlar Fans	Sayı Number	Güç Power	Ses Basınç Seviyesi Sound Pressure Level	Batarya Coil	Tava D.Tray	Toplam Güç Total Power
	m ²	kW	kW	kW	kW	m ³ /h	m	m	dm ³	mm	mm	mm	mm	n	kW	(3m)dB(A)	kW	kW	kW
 x 1	1G2.40.1.12.L	11.3	2.2	1.6	1.3	2470	10	20	6.0	21.3	21.3	21.3	400	1	0.12	39	1.30	0.65	1.95
	1G4.40.1.12.L	16.9	3.2	2.4	1.9	2220	9	18	10.0	21.3	21.3	21.3	400	1	0.12	39	1.95	0.65	2.60
	1G6.40.1.12.L	22.6	3.9	3.0	2.4	2010	8	16	14.8	21.3	21.3	21.3	400	1	0.12	39	2.60	0.65	3.25
	1G2.45.1.12.L	16.7	3.5	2.7	2.2	3780	11	26	8.4	21.3	21.3	21.3	450	1	0.19	38	2.40	0.80	3.20
	1G4.45.1.12.L	25.0	4.9	3.6	3.0	3500	10	24	13.9	21.3	21.3	21.3	450	1	0.19	38	3.20	0.80	4.00
	1G6.45.1.12.L	33.4	6.0	4.5	3.6	3220	10	22	16.9	21.3	33.7	21.3	450	1	0.19	38	4.00	0.80	4.80
	1G2.50.1.12.L	27.8	5.3	3.9	3.2	5290	14	27	12.4	21.3	33.7	21.3	500	1	0.29	45	4.00	2.00	6.00
	1G4.50.1.12.L	41.7	7.7	5.8	4.7	5060	14	26	19.5	21.3	33.7	21.3	500	1	0.29	45	5.00	2.00	7.00
	1G6.50.1.12.L	55.6	9.2	6.8	5.4	4820	13	25	24.8	21.3	33.7	21.3	500	1	0.29	45	6.00	2.00	8.00
	1G2.63.1.12.L	41.7	9.1	6.8	5.6	9860	21	38	18.3	21.3	33.7	21.3	630	1	0.63	52	7.20	2.40	9.60
	1G4.63.1.12.L	62.5	12.9	9.6	7.8	9440	20	36	27.5	21.3	33.7	21.3	630	1	0.63	52	8.40	2.40	10.80
1G6.63.1.12.L	83.4	16.2	12.2	9.9	9050	19	35	36.7	21.3	42.4	21.3	630	1	0.63	52	9.60	2.40	12.00	
 x 2	1G2.40.2.12.L	22.6	4.7	3.5	2.9	4940	11	22	10.6	21.3	21.3	21.3	400	2	0.24	42	2.60	1.30	3.90
	1G4.40.2.12.L	33.9	6.4	4.8	3.9	4430	10	20	15.3	21.3	33.7	21.3	400	2	0.24	42	3.90	1.30	5.20
	1G6.40.2.12.L	45.2	7.9	5.9	4.8	4010	9	18	21.1	21.3	33.7	21.3	400	2	0.24	42	5.20	1.30	6.50
	1G2.45.2.12.L	33.4	7.0	5.3	4.3	7550	12	29	14.4	21.3	33.7	21.3	450	2	0.38	41	4.80	1.60	6.40
	1G4.45.2.12.L	50.0	9.8	7.3	6.0	6990	12	26	21.6	21.3	33.7	21.3	450	2	0.38	41	6.40	1.60	8.00
	1G6.45.2.12.L	66.7	11.9	9.0	7.3	6430	11	24	28.8	21.3	33.7	21.3	450	2	0.38	41	8.00	1.60	9.60
	1G2.50.2.12.L	55.6	10.5	7.8	6.3	10580	16	30	23.1	21.3	33.7	21.3	500	2	0.58	48	8.00	4.00	12.00
	1G4.50.2.12.L	83.4	15.3	11.5	9.4	10110	15	28	35.1	21.3	42.4	21.3	500	2	0.58	48	10.00	4.00	14.00
	1G6.50.2.12.L	111.2	18.2	13.6	10.8	9640	14	27	46.3	21.3	42.4	21.3	500	2	0.58	48	12.00	4.00	16.00
	1G2.63.2.12.L	83.4	18.1	13.6	11.1	19720	23	42	34.6	21.3	42.4	26.9	630	2	1.26	55	14.40	4.80	19.20
	1G4.63.2.12.L	125.1	25.6	19.3	15.8	18870	22	40	51.9	21.3	48.3	26.9	630	2	1.26	55	16.80	4.80	21.60
1G6.63.2.12.L	166.8	32.3	24.3	19.9	18100	21	38	69.2	21.3	48.3	26.9	630	2	1.26	55	19.20	4.80	24.00	
 x 3	1G2.40.3.12.L	33.9	7.1	5.3	4.3	7410	11	23	14.5	21.3	33.7	21.3	400	3	0.36	44	3.90	1.95	5.85
	1G4.40.3.12.L	50.8	9.7	7.2	5.9	6650	10	21	21.7	21.3	33.7	21.3	400	3	0.36	44	5.85	1.95	7.80
	1G6.40.3.12.L	67.8	11.6	8.8	7.1	6030	9	19	28.9	21.3	33.7	21.3	400	3	0.36	44	7.80	1.95	9.75
	1G2.45.3.12.L	50.0	10.6	7.9	6.5	11340	13	30	20.9	21.3	33.7	26.9	450	3	0.57	43	7.20	2.40	9.60
	1G4.45.3.12.L	75.1	14.8	11.1	9.1	10490	12	28	31.4	21.3	42.4	26.9	450	3	0.57	43	9.60	2.40	12.00
	1G6.45.3.12.L	100.1	18.0	13.5	10.9	9650	11	25	41.8	21.3	42.4	26.9	450	3	0.57	43	12.00	2.40	14.40
	1G2.50.3.12.L	83.4	16.5	12.4	10.1	15870	16	31	34.5	21.3	42.4	26.9	500	3	0.87	50	12.00	6.00	18.00
	1G4.50.3.12.L	125.1	23.1	17.3	14.1	15160	16	30	51.7	21.3	42.4	26.9	500	3	0.87	50	15.00	6.00	21.00
	1G6.50.3.12.L	166.8	28.7	21.5	17.6	14460	15	28	68.9	21.3	48.3	26.9	500	3	0.87	50	18.00	6.00	24.00
	1G2.63.3.12.L	125.1	26.6	20.2	16.4	29570	24	44	51.2	21.3	48.3	33.7	630	3	1.89	57	21.60	7.20	28.80
	1G4.63.3.12.L	187.6	37.6	28.4	23.1	28300	23	42	76.8	21.3	60.3	33.7	630	3	1.89	57	25.20	7.20	32.40
1G6.63.3.12.L	250.2	47.3	35.7	28.9	27150	22	40	102.4	26.9	60.3	33.7	630	3	1.89	57	28.80	7.20	36.00	
 x 4	1G2.40.4.12.L	45.2	9.6	7.1	5.8	9870	12	24	19.0	21.3	33.7	26.9	400	4	0.48	45	5.20	2.60	7.80
	1G4.40.4.12.L	67.8	13.1	9.8	7.9	8880	10	22	28.6	21.3	33.7	26.9	400	4	0.48	45	7.80	2.60	10.40
	1G6.40.4.12.L	90.3	15.9	11.8	9.7	8040	9	20	38.1	21.3	42.4	26.9	400	4	0.48	45	10.40	2.60	13.00
	1G2.45.4.12.L	66.7	14.1	10.6	8.7	15120	14	31	27.5	21.3	33.7	26.9	450	4	0.76	44	9.60	3.20	12.80
	1G4.45.4.12.L	100.1	19.6	14.7	11.9	14000	13	29	41.3	21.3	42.4	26.9	450	4	0.76	44	12.80	3.20	16.00
	1G6.45.4.12.L	133.4	24.0	18.0	14.6	12880	12	27	55.1	21.3	42.4	26.9	450	4	0.76	44	16.00	3.20	19.20
	1G2.50.4.12.L	111.2	21.0	15.8	12.6	21150	17	32	45.5	21.3	42.4	26.9	500	4	1.16	51	16.00	8.00	24.00
	1G4.50.4.12.L	166.8	29.5	21.9	17.5	20220	16	31	68.2	21.3	48.3	26.9	500	4	1.16	51	20.00	8.00	28.00
	1G6.50.4.12.L	222.4	36.5	27.1	21.5	19280	16	30	91.0	21.3	60.3	26.9	500	4	1.16	51	24.00	8.00	32.00
	1G2.63.4.12.L	166.8	36.4	27.3	22.4	39430	25	45	68.2	21.3	48.3	33.7	630	4	2.52	58	28.80	9.60	38.40
	1G4.63.4.12.L	250.2	51.4	38.6	31.6	37730	24	44	102.3	26.9	60.3	33.7	630	4	2.52	58	33.60	9.60	43.20
1G6.63.4.12.L	333.6	64.8	48.7	39.9	36190	23	42	136.4	33.7	76.1	33.7	630	4	2.52	58	38.40	9.60	48.00	

*Katalogta verilen üfleme mesafesi değerleri ideal durum içindir. Fanların üfleme performansı çalışma koşullarına bağlı olarak (oda içi yerleşim, hava sıcaklığı, kar kalınlığı vb.) değişiklik gösterir.

*The indicated air throws are valid for ideal conditions. Fans' air throw performance may vary because of the surrounding conditions such as spatial dimensions, installation, air cooling, frost formation.

NES • 4 • 7 • 10 • 12 mm

BOYUTLAR / DIMENSIONS

MODEL MODEL	L	C	C1	C2	E	M	H	B	W	S	A	Y	Dişli Drainaj Bağlantısı Drain (G-Thread) Connection	Ağırlık* / Weight			
														4 mm	7 mm	10 mm	12 mm
														kg	kg	kg	kg
mm	mm	mm	mm	mm	mm	mm	mm	mm	mm	mm	mm	mm	inch	kg	kg	kg	kg
1G2.40.1.-	1144	700	-	-	222	660	580	530	720	615	150	585	1 1/4"	40	36	34	33
1G4.40.1.-	1144	700	-	-	222	660	580	530	720	615	150	585	1 1/4"	50	43	40	39
1G6.40.1.-	1144	700	-	-	222	660	580	660	850	745	150	715	1 1/4"	62	53	50	48
1G2.45.1.-	1294	850	-	-	222	790	710	530	690	615	120	585	1 1/4"	54	48	45	44
1G4.45.1.-	1294	850	-	-	222	790	710	530	690	615	120	585	1 1/4"	68	58	54	52
1G6.45.1.-	1294	850	-	-	222	790	710	660	820	745	120	715	1 1/4"	84	71	66	64
1G2.50.1.-	1494	1050	-	-	222	960	880	530	710	615	140	585	1 1/4"	112	101	97	95
1G4.50.1.-	1494	1050	-	-	222	960	880	660	840	745	140	715	1 1/4"	142	126	119	117
1G6.50.1.-	1494	1050	-	-	222	960	880	660	840	745	140	715	1 1/4"	163	142	133	130
1G2.63.1.-	1694	1270	-	-	212	1160	1080	615	860	665	224	685	2"	181	165	158	156
1G4.63.1.-	1694	1270	-	-	212	1160	1080	815	1060	865	224	885	2"	230	206	197	193
1G6.63.1.-	1694	1270	-	-	212	1160	1080	815	1060	865	224	885	2"	262	229	216	211
1G2.80.1.-	2094	1670	-	-	212	1360	1280	715	1020	765	284	785	2"	289	263	253	249
1G4.80.1.-	2094	1670	-	-	212	1360	1280	915	1220	965	284	985	2"	362	323	307	301
1G6.80.1.-	2094	1670	-	-	212	1360	1280	915	1220	965	284	985	2"	410	358	338	330
1G2.40.2.-	1794	1350	675	-	222	660	580	530	720	615	150	585	1 1/4"	65	57	53	52
1G4.40.2.-	1794	1350	675	-	222	660	580	530	720	615	150	585	1 1/4"	83	70	64	62
1G6.40.2.-	1794	1350	675	-	222	660	580	660	850	745	150	715	1 1/4"	104	86	79	76
1G2.45.2.-	2094	1650	825	-	222	790	710	530	690	615	120	585	1 1/4"	92	79	74	72
1G4.45.2.-	2094	1650	825	-	222	790	710	530	690	615	120	585	1 1/4"	116	97	89	86
1G6.45.2.-	2094	1650	825	-	222	790	710	660	820	745	120	715	1 1/4"	146	120	109	105
1G2.50.2.-	2494	2050	1025	-	222	960	880	530	710	615	140	585	1 1/4"	187	165	157	153
1G4.50.2.-	2494	2050	1025	-	222	960	880	660	840	745	140	715	1 1/4"	239	207	194	189
1G6.50.2.-	2494	2050	1025	-	222	960	880	660	840	745	140	715	1 1/4"	279	236	219	213
1G2.63.2.-	2894	2470	1235	-	212	1160	1080	615	860	665	224	685	2"	312	280	267	262
1G4.63.2.-	2894	2470	1235	-	212	1160	1080	815	1060	865	224	885	2"	399	351	331	324
1G6.63.2.-	2894	2470	1235	-	212	1160	1080	815	1060	865	224	885	2"	458	394	368	358
1G2.80.2.-	3694	3270	1635	-	212	1360	1280	715	1020	765	284	785	2"	509	457	437	429
1G4.80.2.-	3694	3270	1635	-	212	1360	1280	915	1220	965	284	985	2"	639	562	531	519
1G6.80.2.-	3694	3270	1635	-	212	1360	1280	915	1220	965	284	985	2"	732	629	588	572
1G2.40.3.-	2444	2000	675	650	222	660	580	530	720	615	150	585	2"	91	78	73	71
1G4.40.3.-	2444	2000	675	650	222	660	580	530	720	615	150	585	2"	116	96	88	85
1G6.40.3.-	2444	2000	675	650	222	660	580	660	850	745	150	715	2"	145	119	109	105
1G2.45.3.-	2894	2450	825	800	222	790	710	530	690	615	120	585	2"	173	153	146	143
1G4.45.3.-	2894	2450	825	800	222	790	710	530	690	615	120	585	2"	208	179	168	163
1G6.45.3.-	2894	2450	825	800	222	790	710	660	820	745	120	715	2"	257	219	203	197
1G2.50.3.-	3494	3050	1025	1000	222	960	880	530	710	615	140	585	2"	271	239	226	221
1G4.50.3.-	3494	3050	1025	1000	222	960	880	660	840	745	140	715	2"	347	298	279	271
1G6.50.3.-	3494	3050	1025	1000	222	960	880	660	840	745	140	715	2"	405	341	315	305
1G2.63.3.-	4094	3670	1235	1200	212	1160	1080	615	860	665	224	685	2"	442	393	374	366
1G4.63.3.-	4094	3670	1235	1200	212	1160	1080	815	1060	865	224	885	2"	565	493	464	453
1G6.63.3.-	4094	3670	1235	1200	212	1160	1080	815	1060	865	224	885	2"	652	555	517	502
1G2.80.3.-	5294	4870	1635	1600	212	1360	1280	715	1020	765	284	785	2"	727	649	618	606
1G4.80.3.-	5294	4870	1635	1600	212	1360	1280	915	1220	965	284	985	2"	914	798	751	733
1G6.80.3.-	5294	4870	1635	1600	212	1360	1280	915	1220	965	284	985	2"	1051	896	835	810
1G2.40.4.-	3094	2650	675	650	222	660	580	530	720	615	150	585	2"	160	142	135	133
1G4.40.4.-	3094	2650	675	650	222	660	580	530	720	615	150	585	2"	192	166	156	151
1G6.40.4.-	3094	2650	675	650	222	660	580	660	850	745	150	715	2"	238	203	189	184
1G2.45.4.-	3694	3250	825	800	222	790	710	530	690	615	120	585	2"	222	196	186	182
1G4.45.4.-	3694	3250	825	800	222	790	710	530	690	615	120	585	2"	269	230	215	209
1G6.45.4.-	3694	3250	825	800	222	790	710	660	820	745	120	715	2"	332	280	260	252
1G2.50.4.-	4494	4050	1025	1000	222	960	880	530	710	615	140	585	2"	348	305	288	281
1G4.50.4.-	4494	4050	1025	1000	222	960	880	660	840	745	140	715	2"	447	382	356	346
1G6.50.4.-	4494	4050	1025	1000	222	960	880	660	840	745	140	715	2"	524	438	403	390
1G2.63.4.-	5294	4870	1235	1200	212	1160	1080	615	860	665	224	685	2"	571	507	481	471
1G4.63.4.-	5294	4870	1235	1200	212	1160	1080	815	1060	865	224	885	2"	732	635	596	581
1G6.63.4.-	5294	4870	1235	1200	212	1160	1080	815	1060	865	224	885	2"	846	717	666	646
1G2.80.4.-	6894	6470	1635	1600	212	1360	1280	715	1020	765	284	785	2"	944	841	800	784
1G4.80.4.-	6894	6470	1635	1600	212	1360	1280	915	1220	965	284	985	2"	1189	1034	972	948
1G6.80.4.-	6894	6470	1635	1600	212	1360	1280	915	1220	965	284	985	2"	1370	1164	1081	1049

*Ağırlıklar yaklaşık olarak hesaplanmıştır.
* The weights are calculated approximately.

NES • 4 • 7 • 10 • 12 mm

TEKNİK ÇİZİM / DRAWING

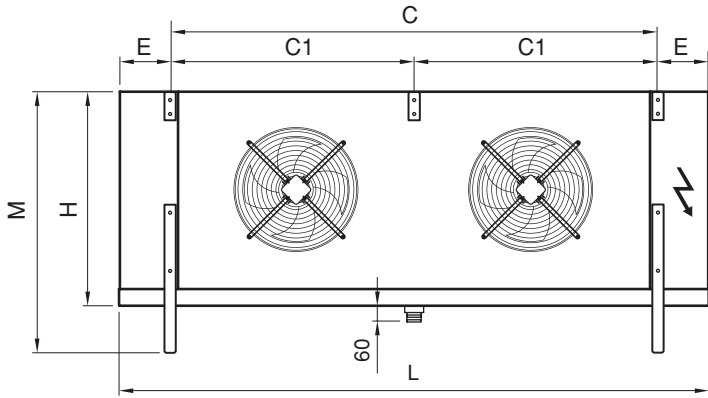
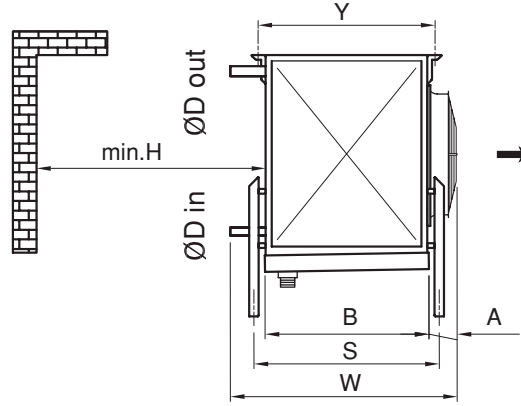
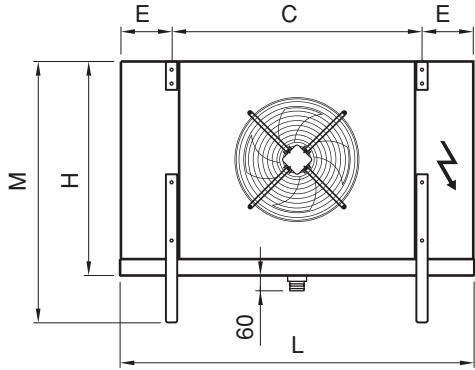

ASKI AYAKLARI / CEILING HANGERS

040-045-050

063-080

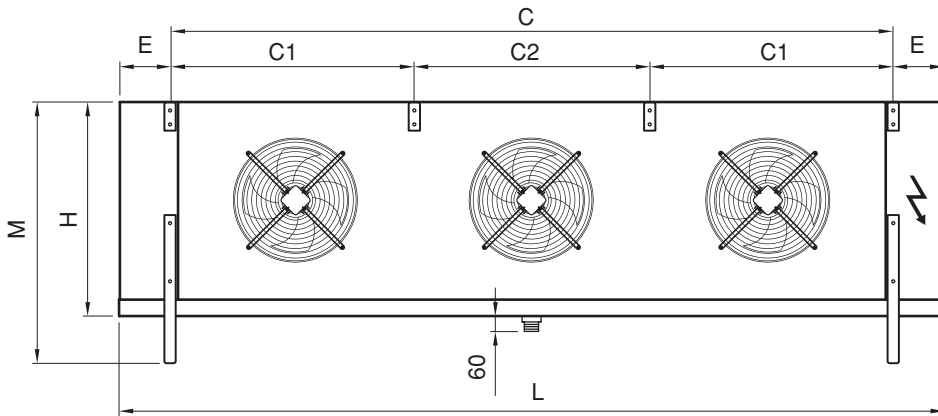
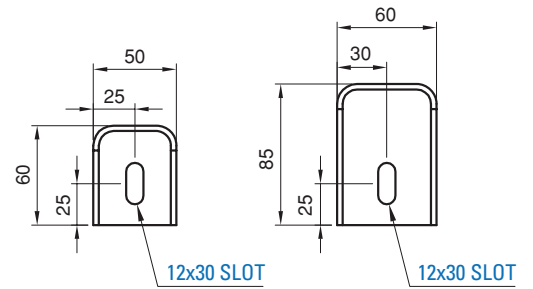

ALT AYAK / BASE PLATE

